

BOMANN®

Home Appliances 2018



CONTENT



Coffee machines	7
Coffee grinder	10
Espresso machine	10
Kettle	12
Milk frother	11



Crêpe maker	21
Egg boiler	26
Ice cream cone maker	21
Ice cube maker	24
Muffin maker	22
Multigrill	23
Pepper/salt mill	25
Sandwich toaster	22
Soft ice maker	24
Toaster	15
Waffle maker	17
Yogurt maker	24



Automatic juicer	39
Bag sealer	42
Citrus fruit squeezer	39
Deep fat fryers	43
Fondue deep fat pan	42
Food dryer	41

Food processor	36
Metal food slicer	25
Hand blender	26
Hand blender set	27
Hand mixer	29
Hand mixer sets	30
Kitchen scales	41
Kneading machines	31
Mincer	37
Multi chopper	28
Smoothie maker	38
Spiral cutter	27
Universal mixer	37



Bread maker	45
Barbecue standing grill	49
Barbecue table grill	50
Built-in microwaves with grill	56
Contact grill	47
Convection oven	51
Hot dog maker	46
Hotplates	58
Induction hot plates	59
Microwaves	53
Mini oven	52
Multi pizza oven	52
Raclette grills	48
Rice boiler	45
Steam cooker	46
Party pan	48
Vertical Kebab Multigrill	51



Steam irons	63
Steam ironing units	65
Textile cleaner	62



Battery floor vacuum cleaner	67
Battery vacuum cleaner	65
Floor vacuum cleaner	68
Hand vacuum cleaner	66
Shampoo cleaner	75
Steam cleaner	64
Steam mop	65
Wet and dry cleaner	74



Bathroom scales	76
Foot massage equipment	76
Hair and beard trimmer	77
Hot air styler	78
Hair dryer	78
Nose and ear hair remover	77
Hot air curling brush	78



Accessoires	85
Air dehumidifier	81
Cool boxes	83
Ventilators	80
Wine cooler	84
Fan heater	81



Coffee machine KA 1575 CB

- For 8–10 cups of coffee (approx. 1,25 litre)
- Anti-drip protection
- Swivel filter
- On/off switch with indicator light (blue illuminated)
- Water level indicator
- Heating plate with automatic switch-off
- 230 V, 50 Hz, 870 W max.



Kettle WK 5011 CB

- Max. capacity 1.7 litre
- Simple handling due to cable-free technology – easy to pour in and out
- Safety hinged lid with one-handed operation
- Lime filter (removable)
- On/off switch (illuminated)
- Stainless steel heating element
- Automatic/manual switch-off
- 2 external water level indicators
- Rubber profile on the handle
- Base station with cord storage
- Evaporation/overheating protection
- 220–240 V, 50 Hz, 1850–2200 W



Automatic toaster TA 1577 CB

- Compact 2-slice toaster
- Cool touch housing
- Bun warmer (removable)
- Defrost/reheat/quick-stop function
- Continuously adjustable browning
- 3 indicator lights (blue illuminated)
- Automatic/manual switch-off
- Crumb drawer
- Cord storage
- 230 V, 50 Hz, 870 W max.



Coffee machine KA 1575 CB

- For 8–10 cups of coffee (approx. 1.25 litre)
- Anti-drip protection
- Swivel filter
- On/off switch with indicator light (blue illuminated)
- Water level indicator
- Heating plate with automatic switch-off
- 220–240 V, 50/60 Hz, 730–870 W

Automatic toaster TA 1577 CB

- Compact 2-slice toaster
- Cool touch housing
- Bun warmer (removable)
- Defrost/reheat/quick-stop function
- Continuously adjustable browning
- 3 indicator lights (blue illuminated)
- Automatic/manual switch-off
- Crumb drawer
- Cord storage
- 230 V, 50 Hz, 870 W max.

Kettle WK 5011 CB

- Max. capacity 1.7 litre
- Simple handling due to cable-free technology – easy to pour in and out
- Safety hinged lid with one-handed operation
- Lime filter (removable)
- On/off switch (illuminated)
- Stainless steel heating element
- Automatic/manual switch-off
- 2 external water level indicators
- Rubber profile on the handle
- Base station with cord storage
- Evaporation/overheating protection
- 220–240 V, 50 Hz, 1850–2200 W

3in1

Coffee machine
Automatic toaster
Kettle



6

Coffee machine KA 1501 CB

- For 8–10 cups of coffee
- Anti-drip protection
- On/off switch with indicator light
- Swivel filter
- Water level indicator
- Heating plate with automatic switch-off
- 220–240 V, 50/60 Hz, 730–870 W
- WxHxD approx. 210 x 300 x 220 mm

Kettle WK 1502 CB

- Max. capacity 1.7 litre
- Cordless, for easy using
- Nylon filter (removable)
- On/off switch with indicator light
- Automatic/manual switch-off
- 2 external water level indicators
- Evaporation/overheating protection
- 220–240 V, 50 Hz, 1850–2200 W
- WxHxD approx. 250 x 265 x 135 mm

Automatic toaster TA 1503 CB

- 2-slice toaster
- Cool touch housing
- Continuously adjustable thermostat
- Defrost/reheat/quick-stop function
- Lift function
- Crumb drawer (removable)
- Bun warmer (integrated)
- Base station with cord storage
- 230 V, 50 Hz, 800 W
- WxHxD approx. 275 x 180 x 180 mm

FS 1500 CB Breakfast-Set black

● Art. no. 615 001
EAN 4 004 470 150 018

PU 4

- Sales Packaging
WxHxD approx. 515 x 312 x 240 mm



ETM TESTMAGAZIN - URTEIL	
Bomann KA 180 CB 1-Tassen Kaffeeautomat	
GUT	81,3 %
Im Test: 6 Coffee to go-Maschinen Testurteile: 2x sehr gut, 4x gut	Heft 05/2015



1-cup coffee machine KA 180 CB

- „Coffee to go“ – simple, quick, and fresh, with the familiar taste of an aromatic filter coffee
- Ideal for camping, in the office, at home or on the way
- Incl. thermo stainless steel cup with drink opening and heat insulated aroma seal lid
- 300 ml capacity
- Permanent nylon filter (removable)
- Cup fits virtually all standard cup holders
- Rubberized „Soft Touch“ handle
- On/off switch
- Automatic power off
- Indicator light
- 220–240 V, 50 Hz, 420 W
- WxHxD approx. 155 x 235 x 150 mm

1 cup coffee machine KA 201 CB

- 1 cup coffee machine for filter coffee
- Space-saving design (ideal when out and about)
- Includes one ceramic cup
- Permanent nylon filter (removable)
- On/off switch with indicator light
- Automatic power off
- Nonslip tray (removable)
- 220–240 V, 50 Hz, 270–330 W
- WxHxD approx. 130 x 175 x 155 mm

Coffee machine KA 1575 CB

- For 8–10 cups of coffee (approx. 1,25 litre)
- Anti-drip protection
- Swivel filter
- On/off switch with indicator light (blue illuminated)
- Water level indicator
- Heating plate with automatic switch-off
- 220–240 V, 50/60 Hz, 730–870 W
- WxHxD approx. 165 x 300 x 250 mm

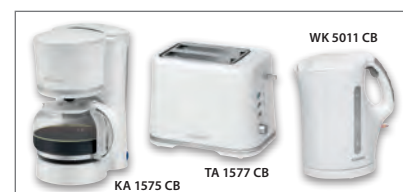

Can also be combined as a suitable breakfast set

● Art. no. 601 801
EAN 4 004 470 018 011 PU 6



● Art. no. 602 011
EAN 4 004 470 020 113 PU 6



● Art. no. 615 750
EAN 4 004 470 157 505 PU 6
● Art. no. 615 751
EAN 4 004 470 157 512 PU 6





Coffee machine
KA 183 CB

NEW! Coffee machine
KA 183 CB

NEW! Coffee machine
KA 3003 CB

- For 12–14 cups of coffee (approx. 1.5 litre)
 - Anti-drip protection
 - Filter holder (removable)
 - On/off switch (illuminated)
 - Water level indicator
 - Heating plate with automatic switch-off
 - Cord storage
- 230 V, 50 Hz, 900 W
 - W x H x D approx. 190 x 330 x 205 mm

- For 12–14 cups of coffee (approx. 1.5 litre)
 - Anti-drip protection
 - Filter holder (removable)
 - On/off switch (illuminated)
 - Water level indicator
 - Heating plate with automatic switch-off
 - Cord storage
- 230 V, 50 Hz, 900 W
 - W x H x D approx. 190 x 330 x 205 mm

- For 15 cups of coffee (approx. 1.7 litre)
 - Stainless steel insert
 - Anti-drip protection
 - Filter holder (removable)
 - On/off switch with indicator light
 - Water level indicator
 - Heating plate with automatic switch-off
- 220–240 V, 50/60 Hz, 1000 W
 - W x H x D approx. 220 x 340 x 260 mm



Can also be combined as a suitable kitchen set



Can also be combined as a suitable breakfast set

- Art. no. 601 830
EAN 4 004 470 018 301 PU 6
- Art. no. 601 833
EAN 4 004 470 018 332 PU 6



- Art. no. 601 831
EAN 4 004 470 018 318 PU 6
- Art. no. 601 832
EAN 4 004 470 018 325 PU 6



- Art. no. 630 031
EAN 4 004 470 300 314 PU 4
- Art. no. 630 032
EAN 4 004 470 300 369 PU 4





Coffee machine
KA 1369 CB

- For 12–14 cups of coffee (approx. 1.5 litre)
- High-quality stainless steel application
- Anti-drip protection
- Filter holder (removable)
- On/off switch with indicator light (blue illuminated)
- Water level indicator
- Heating plate with automatic switch-off

- 220–240 V, 50/60 Hz, 900 W
- W x H x D approx. 180 x 325 x 260 cm

Thermo coffee machine
KA 168 CB

- For 8–10 cups of coffee (approx. 1.0 litre)
- Thermo jug (double-walled)
- Anti-drip protection
- Filter holder (removable)
- On/off switch with indicator light
- Automatic power off
- Water level indicator

- 220–240 V, 50/60 Hz, 730–870 W
- W x H x D approx. 185 x 340 x 210 mm

Thermo coffee machine
KA 1370 CB

- For 8–10 cups of coffee (approx. 1.2 litre)
- Stainless steel thermo jug (double-walled) with aroma seal – drinks remain hot for longer
- High-quality stainless steel application
- Anti-drip protection
- Filter holder (removable)
- On/off switch with indicator light (blue illuminated)
- Automatic power off
- Water level indicator

- 220–240 V, 50 Hz, 800 W
- W x H x D approx. 180 x 325 x 260 cm



Double-walled thermo jug with aroma seal – drinks remain hot for longer

Art. no. 613 691
EAN 4 004 470 136 913

PU 4



Art. no. 601 680
EAN 4 004 470 016 802
Art. no. 601 683
EAN 4 004 470 016 871

PU 6

PU 6



Art. no. 613 701
EAN 4 004 470 137 019

PU 4





Stainless steel housing

10

Espresso machine ES 1185 CB

- Espresso and cappuccino pump machine
 - Stainless steel front
 - Swiveling stainless steel steam nozzle with foaming and hot water function
 - Steam volume steplessly adjustable
 - Steam nozzle tip removable for easy cleaning
 - Cup warming function with stainless steel insert
 - Constant pump pressure of 15 bar
 - 1.6 litre transparent water tank (removable)
 - External water level indicator
 - Collection cup with stainless steel drip grid (removable)
 - 2 indicator lights
 - Automatic shut-off
 - Operational readiness indication
 - Accessories: 2 filter holders (1 and 2 cups), coffee scoop, tamper
- 220–240 V, 50 Hz, 850 W
■ WxHxD approx. 250 x 295 x 280 mm



Cup warming function



Swiveling stainless steel steam nozzle with foaming and hot water function

Coffee grinder KSW 445 CB

- Electric coffee mill with beater
 - Stainless steel beater blade
 - Stainless steel bean container, hygienic and with aroma protection
 - Transparent lid
 - Capacity 40 g – for 20 cups of coffee
 - With 120 watt motor
 - Safety circuit – operation only possible with lid in place
 - Safety pushbutton also for pulsed operation
 - Degree of grinding can be selected by the length of operation
 - Cord storage
- 220–240, 50 Hz, 120 W
■ WxHxD approx. 100 x 200 x 100 mm

Coffee grinder KSW 446 CB

- Electric coffee mill with beater
 - Stainless steel beater blade
 - Stainless steel bean container, hygienic and with aroma protection
 - Transparent lid
 - Capacity 40 g – for 20 cups of coffee
 - With 120 watt motor
 - Safety circuit – operation only possible with lid in place
 - Safety pushbutton also for pulsed operation
 - Degree of grinding can be selected by the length of operation
 - Cord storage
- 220–240 V, 50 Hz, 120 W
■ WxHxD approx. 100 x 200 x 100 mm

● Art. no. 611 851
EAN 4 004 470 118 513 PU 2



● Art. no. 604 451
EAN 4 004 470 044 515 PU 6



● Art. no. 604 460
EAN 4 004 470 044 607 PU 6





Cold and warm foaming function

Milk frother
MS 479 CB

- Integrated heating function
- Creates foamy milk in seconds
- Also suitable for hot and cold chocolate
- Stainless steel container (700 ml)
- Insulated soft-touch coating
- Foamed milk volume: approx. 500 ml
- Electronic 2-function switch
 - Froth the milk warm
 - Froth the milk cold – ideal for iced coffee
 - Heat the milk
- Built-in heating element
- Automatic switch-off function
- Incl. lid with splash guard function
- Additional stirrer for hot drinks without frothing (e.g. cocoa)
- Mixing bowl and lid removable for easy cleaning
- 220–240 V, 50 Hz, 550–650 W
- W x H x D approx. 105 x 240 x 105 mm



Cold and warm foaming function

Glass milk frother
MS 376 CB

- No preheating of the milk thanks to the integrated heating function
- Creates foamy milk in seconds
- Also suitable for hot and cold chocolate
- Glass container (750 ml) with stainless steel handle
- Amount of milk foam: approx. 300 ml
- Electronic 3 function switch
 - Froth the milk warm
 - Froth the milk cold – ideal for iced coffee
 - Heat the milk
- Built-in heating element
- Automatic switch-off function
- Incl. lid with splash guard function
- Additional stirrer hot drinks without foaming (e.g. cacao)
- Glass container and lid removable for easy cleaning
- 220–240 V, 50 Hz, 600–650 W
- W x H x D approx. 120 x 180 x 175 mm



Milk frother
MS 344 CB

- Creates foamy milk in seconds
- Soft touch housing
- Stainless steel whisk
- Easy to clean
- Battery operation: 2 x 1,5 V AA/UM 3 (batteries not included)
- W x H x D approx. 47 x 225 x 32 mm



Kettle
WK 5024 CB

- Max. capacity 1.0 litre
 - Simple handling due to cable-free technology – easy to pour in and out
 - Safety hinged lid with one-handed operation
 - Lime filter (removable)
 - On/off switch (illuminated)
 - Stainless steel heating element
 - Automatic/manual switch-off
 - 2 external water level indicators
 - Rubber profile on the handle
 - Incl. base station
 - Evaporation/overheating protection
- 220–240 V, 50 Hz, 750–900 W
■ WxHxD approx. 185 x 220 x 115 mm

Kettle
WK 5011 CB

- Max. capacity 1.7 litre
 - Simple handling due to cable-free technology – easy to pour in and out
 - Safety hinged lid with one-handed operation
 - Lime filter (removable)
 - On/off switch (illuminated)
 - Stainless steel heating element
 - Automatic/manual switch-off
 - 2 external water level indicators
 - Rubber profile on the handle
 - Base station with cord storage
 - Evaporation/overheating protection
- 220–240 V, 50 Hz, 1850–2200 W
■ WxHxD approx. 220 x 255 x 140 mm

Kettle
WK 5011 CB

- Max. capacity 1.7 litre
 - Simple handling due to cable-free technology – easy to pour in and out
 - Safety hinged lid with one-handed operation
 - Lime filter (removable)
 - On/off switch (illuminated)
 - Stainless steel heating element
 - Automatic/manual switch-off
 - 2 external water level indicators
 - Rubber profile on the handle
 - Base station with cord storage
 - Evaporation/overheating protection
- 220–240 V, 50 Hz, 1850–2200 W
■ WxHxD approx. 220 x 255 x 140 mm

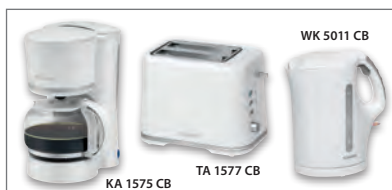

Can also be combined as a suitable breakfast set



Can also be combined as a suitable kitchen set

- Art. no. 650 240
EAN 4 004 470 502 404 PU 6
- Art. no. 650 241
EAN 4 004 470 502 411 PU 6



- Art. no. 650 110
EAN 4 004 470 501 100 PU 6
- Art. no. 650 113
EAN 4 004 470 501 131 PU 6
- Art. no. 650 111
EAN 4 004 470 501 117 PU 6



- Art. no. 650 118
EAN 4 004 470 501 186 PU 6
- Art. no. 650 119
EAN 4 004 470 501 193 PU 6





Kettle
WK 5012 CB

- Max. capacity 1.8 litre
 - Simple handling due to cable-free technology – easy to pour in and out
 - 360° connector
 - Lockable safety hinged lid with one-handed operation
 - Lime filter (removable)
 - On/off switch (illuminated)
 - Concealed stainless steel heating element
 - Automatic/manual switch-off
 - 2 external water level indicators
 - Base station with cord storage
 - Overheating protection
- 220–240 V, 50 Hz, 1850–2200 W
■ WxHxD approx. 225 x 255 x 150 mm

NEW! **Kettle**
WK 3004 CB

- Max. capacity 1.7 litre
 - Stainless steel insert
 - Simple handling due to cable-free technology – easy to pour in and out
 - Safety hinged lid with one-handed operation
 - Lime filter (removable)
 - On/off switch (illuminated)
 - Concealed stainless steel heating element
 - Automatic/manual switch-off
 - 2 external water level indicators
 - Base station with cord storage
 - Evaporation/overheating protection
- 220–240 V, 50/60 Hz, 1850–2200 W
■ WxHxD approx. 220 x 250 x 155 mm



Can also be combined as a suitable breakfast set

● Art. no. 650 120
EAN 4 004 470 501 209 PU 6
● Art. no. 650 123
EAN 4 004 470 501 216 PU 6



● Art. no. 630 041
EAN 4 004 470 300 413 PU 4
● Art. no. 630 042
EAN 4 004 470 300 420 PU 4





Stainless steel

Stainless steel

Kettle WKS 1581 CB

- Max. capacity 1.5 litre
 - Stainless steel insert
 - Simple handling due to cable-free technology – easy to pour in and out
 - 360° connector
 - Lockable safety hinged lid with one-handed operation
 - Lime filter (removable)
 - On/off switch (illuminated)
 - Concealed stainless steel heating element
 - Automatic/manual switch-off
 - 2 external water level indicators
 - Base station with cord storage
 - Evaporation/overheating protection
- 220–240 V, 50/60 Hz, 1850–2200 W
■ W x H x D approx. 155 x 245 x 215 mm

Travel kettle WKR 1162 CB

- Ideal when traveling and on the move
 - Max. capacity 0.5 litre
 - Stainless steel housing
 - Incl. 2 cups à 170 ml, transport / travel bag and coffee spoon
 - Concealed stainless steel heating element
 - Indicator light
 - Automatic switch-off
 - Evaporation/overheating protection
- 120/230 V, 50/60 Hz, 1000 W
■ W x H x D approx. 160 x 170 x 105 mm

Kettle WKS 1361 CB

- Max. capacity 1.0 litre
 - Stainless steel thermo housing
 - Simple handling due to cable-free technology – easy to pour in and out
 - 360° connector
 - Lockable safety hinged lid
 - Lime filter (removable)
 - On/off switch
 - Concealed stainless steel heating element
 - Automatic/manual switch-off
 - Water level indicator
 - Base station with cord storage
 - Evaporation/overheating protection
- 220–240 V, 50/60 Hz, 1850–2200 W
■ W x H x D approx. 220 x 195 x 150 mm



Can also be combined as a suitable breakfast set



Incl. transport / travel bag



Incl. 2 cups à 170 ml + coffee spoon

● Art. no. 615 811
EAN 4 004 470 158 113 PU 6



● Art. no. 611 621
EAN 4 004 470 116 212 PU 6



● Art. no. 613 611
EAN 4 004 470 136 111 PU 6





Stainless steel



Stainless steel

NEW! Kettle
WKS 3002 CB

- Max. capacity 1.5 litre
- Stainless steel housing
- Simple handling due to cable-free technology – easy to pour in and out
- 360° connector
- Safety hinged lid with one-handed operation
- On/off switch (blue illuminated)
- Concealed stainless steel heating element
- Automatic/manual switch-off
- Base station with cord storage
- Evaporation/overheating protection
- 220–240 V, 50 Hz, 1850–2200 W
- W x H x D approx. 230 x 233 x 142 mm

Kettle
WKS 5010 CB

- Max. capacity 1.7 litre
- Simple handling due to cable-free technology – easy to pour in and out
- 360° connector
- Lockable safety hinged lid
- Lime filter (integrated)
- On/off switch (illuminated)
- Stainless steel body
- Concealed stainless steel heating element
- Automatic/manual switch-off
- External water level indicator
- Cord storage
- Evaporation/overheating protection
- 220–240 V, 50 Hz, 2000–2400 W
- W x H x D approx. 230 x 250 x 145 mm

15

● Art. no. 630 022
EAN 4 004 470 300 321 PU 6
● Art. no. 630 021
EAN 4 004 470 300 215 PU 6



● Art. no. 650 100
EAN 4 004 470 501 001 PU 6
● Art. no. 650 103
EAN 4 004 470 501 032 PU 6
● Art. no. 650 101
EAN 4 004 470 501 018 PU 6





Stainless steel



Stainless steel

16

Kettle WKS 1356 CB

- Max. capacity 1.7 litre
- Simple handling due to cable-free technology – easy to pour in and out
- 360° connector
- Lockable safety hinged lid
- Lime filter (removable and washable)
- On/off switch
- Indicator light (blue illuminated)
- Stainless steel thermo housing
- Concealed stainless steel heating element
- Automatic/manual switch-off
- 2 external water level indicators
- Base station with cord storage (stainless steel sheathed)
- Evaporation/overheating protection
- 220–240 V, 50 Hz, 1850–2200 W
- WxHxD approx. 220 x 250 x 145 mm

Water kettle WKS 5031 CB

- Max. capacity 1.8 litre
- Simple handling due to cable-free technology – easy to pour in and out
- 360° connector
- Lime filter (removable, washable)
- On/off switch (illuminated)
- Concealed stainless steel heating element
- Stainless steel water jug
- Automatic/manual switch-off
- External water level indicator
- Base station with cord storage
- Evaporation/overheating protection
- 220–240 V, 50 Hz, 1850–2200 W
- WxHxD approx. 245 x 295 x 225 mm



External water level indicator

Art. no. 613 561
EAN 4 004 470 135 619 PU 6



Art. no. 650 316
EAN 4 004 470 503 166 PU 4
Art. no. 650 311
EAN 4 004 470 503 111 PU 4





Glass kettle
WK 5023 G CB

- Max. capacity 1.7 litre
 - Glass/stainless steel housing
 - Water container made of heat resistant safety glass
 - Simple handling due to cable-free technology – easy to pour in and out
 - 360° connector
 - On/off switch
 - Concealed stainless steel heating element
 - Automatic/manual switch-off
 - Water level indicator
 - Base station with cord storage (stainless steel sheathed)
 - Evaporation/overheating protection
- 220–240 V, 50 Hz, 1850–2200 W
■ W x H x D approx. 220 x 240 x 150 mm



Electric glass kettle
WKS 5032 G CB

- Max. capacity 1.5 litre
 - Glass/stainless steel housing
 - Lockable stainless steel lid with single-handed operation
 - Water container made of heat-resistant safety glass (blue illuminated)
 - Simple handling due to cable-free technology – easy to pour in and out
 - 360° connector
 - On/off switch
 - Concealed stainless steel heating element
 - Automatic/manual switch-off
 - Water level indicator
 - Base station with cord storage (stainless steel sheathed)
 - Evaporation/overheating protection
- 220–240 V, 50/60 Hz, 1850–2200 W
■ W x H x D approx. 220 x 240 x 130 mm



Toaster
TA 246 CB

- Compact 2-slice toaster
 - Cool touch housing
 - Bun warmer (integrated)
 - Defrost/reheat/quick-stop function
 - Continuously adjustable thermostat
 - 2 indicator lights
 - Automatic/manual switch-off
 - Crumb drawer
 - Base station with cord storage
- 220–240 V, 50/60 Hz, 600–700 W
■ W x H x D approx. 285 x 240 x 165 mm



Wasser container made of heat-resistant safety glass (blue illuminated)

● Art. no. 650 231
EAN 4 004 470 502 312 PU 4



● Art. no. 650 321
EAN 4 004 470 503 210 PU 4



● Art. no. 602 460
EAN 4 004 470 024 609 PU 6
● Art. no. 602 463
EAN 4 004 470 024 630 PU 6





18

Toaster
TA 1577 CB

NEW! **Toaster**
TA 1577 CB

- Compact 2-slice toaster
 - Cool touch housing
 - Bun warmer (removable)
 - Defrost/reheat/quick-stop function
 - Continuously adjustable browning
 - 3 indicator lights (blue illuminated)
 - Automatic/manual switch-off
 - Crumb drawer
 - Cord storage
- 220–240 V, 50/60 Hz, 870 W max.
 - WxHxD approx. 260 x 170 x 145 mm

- Compact 2-slice toaster
 - Cool touch housing
 - Bun warmer (removable)
 - Defrost/reheat/quick-stop function
 - Continuously adjustable browning
 - 3 indicator lights (blue illuminated)
 - Automatic/manual switch-off
 - Crumb drawer
 - Cord storage
- 220–240 V, 50/60 Hz, 870 W max.
 - WxHxD approx. 260 x 170 x 145 mm

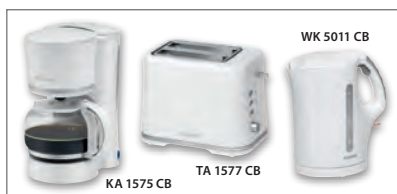

Can also be combined as a suitable breakfast set



Can also be combined as a suitable kitchen set

● **Art. no. 615 770**
EAN 4 004 470 157 703 **PU 6**

● **Art. no. 615 771**
EAN 4 004 470 157 710 **PU 6**



● **Art. no. 615 772**
EAN 4 004 470 157 727 **PU 6**

● **Art. no. 615 773**
EAN 4 004 470 157 734 **PU 6**





NEW! Toaster
TA 3005 CB

- 2-slice toaster
 - Stainless steel insert
 - Cool touch housing
 - Bun warmer (removable)
 - Defrost/reheat/quick-stop function
 - Continuously adjustable thermostat
 - 3 indicator lights (white illuminated)
 - Automatic/manual switch-off
 - Crumb drawer
 - Cord storage
- 220–240 V, 50/60 Hz, 850 W max.
■ WxHxD approx. 295 x 185 x 185 mm

Toaster
TA 1567 CB

- 2-slice toaster
 - Stainless steel insert
 - Cool touch housing
 - Bun warmer (removable)
 - Defrost/reheat/quick-stop function
 - Continuously adjustable thermostat
 - 3 indicator lights
 - Centring function
 - Automatic/manual switch-off
 - Crumb drawer
 - Cord storage
- 220–240 V, 50 Hz, 680–800 W
■ WxHxD approx. 285 x 185 x 170 mm



Can also be combined as a suitable breakfast set

● Art. no. 630 051
EAN 4 004 470 300 512 PU 4
● Art. no. 630 052
EAN 4 004 470 300 529 PU 4



● Art. no. 615 674
EAN 4 004 470 156 744 PU 4





 **Stainless steel housing**

20

Toaster
TA 1371 CB

- 2-slice toaster
- Stainless steel housing
- Bun warmer (removable)
- Defrost/reheat/quick-stop function (blue illuminated)
- Continuously adjustable thermostat
- Centring function
- Automatic/manual switch-off
- Crumb drawer
- Cord storage
- 220–240 V, 50/60 Hz, 750–850 W
- W x H x D approx. 270 x 180 x 150 mm

Toaster
TA 245 CB

- 4-slice long-slot toaster
- Heat-insulated cool touch housing
- Bun warmer (removable)
- Defrost/reheat/quick-stop function
- Continuously adjustable browning
- 3 LED indicator lights
- Automatic switch-off
- Crumb drawer
- Cord storage
- 220–240 V, 50/60 Hz, 1200–1400 W
- W x H x D approx. 375 x 175 x 165 mm

Waffle maker
WA 5018 CB



- Large baking plates: approx. Ø 18 cm (non-stick coated)
- Heat insulated handle
- Continuously adjustable thermostat
- 2 indicator lights for power and heating (baking lights)
- High stability due to rubberized feet
- Overheating protection
- 220–240 V, 50 Hz, 1200 W
- W x H x D approx. 205 x 115 x 250 mm



Defrost/reheat/
quick-stop function
(blue illuminated)

 **Art. no. 613 711**
EAN 4 004 470 137 118 PU 4

 **Art. no. 602 450**
EAN 4 004 470 024 500 PU 6

 **Art. no. 650 180**
EAN 4 004 470 616 798 PU 6
 **Art. no. 650 181**
EAN 4 004 470 501 810 PU 6





Waffle maker
WA 1365 CB

- Stainless steel insert
- Large baking plates: approx. Ø 18 cm (non-stick coated)
- Heat insulated handle
- Continuously adjustable thermostat
- 2 indicator lights for power and heating (baking lights)
- Overheating protection
- 220–240 V, 50/60 Hz, 1000 W
- W x H x D approx. 200 x 100 x 260 mm

Ice cream cone maker
HA 5017 CB

- Large baking plate: approx. Ø 18 cm (non-stick coated)
- Heat insulated handle
- Continuously adjustable thermostat
- 2 indicator lights for power and heating (baking lights)
- High stability due to rubberized feet
- Incl. squirrel cone
- Overheating protection
- 220–240 V, 50 Hz, 1200 W
- W x H x D approx. 205 x 115 x 250 mm

Crêpe maker
CM 2221 CB

- Large baking plate: approx. Ø 29 cm (non-stick coated)
- Paper-thin crêpes, quickly and easily prepared
- Heat-insulated plastic base
- Continuously adjustable thermostat
- 2 indicator lights for power and heating (baking lights)
- Base station with cord storage
- Incl. batter distributor
- 220–240 V, 50/60 Hz, 900 W
- W x H x D approx. 325 x 80 x 370 mm



Stainless steel insert



Incl. squirrel cone



Incl. batter distributor

● Art. no. 613 651
EAN 4 004 470 616 811

PU 4



● Art. no. 650 171
EAN 4 004 470 616 835

PU 6



● Art. no. 622 211
EAN 4 004 470 222 111

PU 4





Muffin maker
MM 5020 CB

- For baking up to 7 muffins
- Muffin diameter approx. 4.5 cm
- Baking surfaces non-stick coated
- Heat insulated handle
- 2 indicator lights for power and heating (baking lights)
- High stability due to rubberized feet
- Overheating protection

- 220–240 V, 50/60 Hz, 900 W
- WxHxD approx. 225 x 115 x 225 mm

Sandwich toaster
ST 5016 CB

- Triangular sandwich plates
- Non-stick coating
- Heat insulated handle
- Automatic temperature controller
- 2 indicator lights for power and heating (baking lights)
- Locking system
- Safety shutdown
- Overheating protection

- 220–240 V, 50/60 Hz, 750 W
- WxHxD approx. 230 x 80 x 230 mm

Sandwich toaster
ST 1372 CB

- Stainless steel insert
- Triangular sandwich plates
- Non-stick coating
- Heat insulated handle
- Automatic temperature control
- 2 indicator lights for power and heating (baking lights)
- High stability due to rubberized feet
- Locking system
- Overheating protection

- 220–240 V, 50/60 Hz, 750 W
- WxHxD approx. 235 x 95 x 235 mm



Stainless steel insert

● Art. no. 650 201
EAN 4 004 470 616 859 PU 6



● Art. no. 650 160
EAN 4 004 470 501 605 PU 6
● Art. no. 650 163
EAN 4 004 470 501 636 PU 6



● Art. no. 613 721
EAN 4 004 470 637 359 PU 6





3in1



Stainless steel housing

Sandwich toaster
ST 1472

Multi grill
ST/WA 1364 CB

Multi grill
MG 2251 CB

- 4-slice sandwich toaster
- Stainless steel insert
- Triangular sandwich plates
- Non-stick coating
- Heat insulated handle
- Automatic temperature control
- 2 indicator lights for power and heating (baking lights)
- High stability due to rubberized feet
- Locking system
- Overheating protection and overtemperature protection

- 220–240 V, 50/60 Hz, 1200 W
- WxHxD approx. 270 x 105 x 325 mm

- Sandwich toaster, waffle maker and contact grill
- Versatile use by three different removable plates (sandwich/waffle/grill plates), e.g. for Belgian waffles and tasty sandwich variations, as well as for fast two-sided contact grilling
- Stainless steel insert
- Baking plates non-stick coated and changeable
- Heat insulated handle
- 2 indicator lights for power and heating (baking lights)
- High stability due to rubberized feet
- Locking system
- Overheating protection

- 230 V, 50/60 Hz, 650 W
- WxHxD approx. 230 x 100 x 225 mm

- Multi grill for double-sided, fat-free grilling
- 700 watts
- Stainless steel housing
- Short cooking times
- Non-stick grill plates with extra deep grooves for strong grill pattern
- Heat insulated handle
- Indicator light
- Grilling surfaces: 23 x 14.5 cm
- Cord storage
- Versatile, can be used for e.g. panini, steaks, fish or vegetables

- 220–240 V, 50/60 Hz, 700W
- WxHxD approx. 270 x 95 x 230 mm



Stainless steel insert



Stainless steel insert



Sandwich plates, waffle plates, grill plates



Stainless steel housing

Art. no. 614 720
EAN 4 004 470 637 366

PU 4



Art. no. 613 641
EAN 4 004 470 616 781

PU 4



Art. no. 622 511
EAN 4 004 470 225 112

PU 6





24

Ice cube maker EWB 1027 CB

- Compact ice cube maker without complicated installation for producing ice cubes quickly and simply at the press of a button
- Ideal for home use, in offices, when camping or for small bars
- No water pipe required, simply fill water into the tank (2.2 l water tank)
- Approx. 10–15 kg of ice cubes in 24 hours (approx. 90 g in 10 min – corresponding to 9 ice cubes)
- LED display and acoustic signal when the ice cube container is full or the water tank is empty
- Energy-saving mode – automatic switch-off at the end of the program
- On/off switch
- 3 indicator lights (ice full, empty water, operation)
- Visual check through viewing window in the lid
- Low-noise
- 220–240 V, 50/60 Hz, 95 W (Cooling), 165 W (spending ice cubes)
- W x H x D approx. 245 x 330 x 370 mm



LED displays



For approx. 10–15 kg ice cubes

Soft ice cream maker ICM 387 CB

- Soft ice cream maker with discharge valve for preparation of soft ice cream, ice cream, frozen yogurt, and sorbet
- Transparent lid with refill opening
- With portioner – ice dispensed directly from the machine
- On/off switch
- Incl. recipe suggestions
- For up to 1000 ml ice cream
- Double-walled ice cream maker with cold storage, removable for easy cleaning (H: 14 cm; Ø 17 cm)
- Stirring element with powerful, quiet motor
- High stability due to rubberized feet
- 220–240 V, 50 Hz, 18 W
- W x H x D approx. 220 x 440 x 225 mm



Soft ice cream maker with discharge valve

Yogurt maker JM 1025 CB

- Easy preparation of up to 1.1 litres of yoghurt
- 7 practical portion jars with screw cap (capacity: 160 ml)
- On/off switch (illuminated)
- Transparent lid
- Additional jars in a set of 6 also available as an optional EG JM 3344, Product number: 251 125
- 220–240 V, 50 Hz, 15 W
- W x H x D approx. 240 x 150 x 265 mm

**Suitable replacement jar:
EG JM 3344**
Art. no.: 251 125
EAN: 4 006 160 511 253



Art. no. 610 271
EAN 4 004 470 102 710 PU 1



Art. no. 603 870
EAN 4 004 470 038 705 PU 2



Art. no. 610 250
EAN 4 004 470 102 505 PU 6



PREIS-/LEISTUNGSSIEGER	
ETM TESTMAGAZIN · URTEIL	
Bomann MA 451 CB	
GUT	83,6 %
Im Test: 10 Alleschneider Testurteile: 1x sehr gut, 8x gut, 1x ausreichend www.etm-testmagazin.de	Heft 10/2015



Egg boiler
EK 5022 CB

Electric pepper/salt mill
PSM 437 N CB

Metal food slicer
MA 451 CB

- Preparation of up to 6 eggs
- Heating dish (non-stick coated)
- On/off switch (illuminated)
- Acoustic signal (buzzer)
- Removable egg holder
- Incl. measuring beaker with egg pricker
- 230 V, 50 Hz, 400 W
- WxHxD approx. 220 x 130 x 135 mm

- High-quality precision ceramic grinder
- Stainless steel housing
- Adjustable ceramic grinder (from coarse to fine)
- Consistent grinding quality
- Simple refilling
- Single-handed operating
- Incl. light for optimum dosing of the condiment
- Battery-operated
- Battery operation:
4x1,5 V AA/Mignon/LR/AM3 (batteries not included)
- WxHxD approx. 45 x 220 x 45 mm

- Big stainless steel blade (Ø 190 mm), rustproof
- Universal serrated blade
- Motor housing: aluminium die cast
- On/off switch
- Metal guiding rail
- Metallic guiding board
- Food grip with finger protection
- Continuously adjustable cutting size (0–15 mm)
- Tilted supporting table with stainless steel insert, tiltable for easy cleaning
- High stability due to suction feet
- 220–240 V, 50/60 Hz, 150 W
- WxHxD approx. 365 x 235 x 265 mm



- Art. no. 650 220
EAN 4 004 470 616 866 PU 6
- Art. no. 650 223
EAN 4 004 470 502 237 PU 6
- Art. no. 650 228
EAN 4 004 470 502 282 PU 6

- Art. no. 604 372
EAN 4 004 470 043 723 PU 6

- Art. no. 604 510
EAN 4 004 470 045 109 PU 2





Incl. transparent mixing vessel



26

Hand blender
SM 354 CB

- Stainless steel cutting blade
- On/off switch (countersunk)
- Incl. transparent mixing vessel (500 ml)
- Hanging loop
- Wall holder plus attachment materials

- 220–240 V, 50 Hz, 180 W
- W x H x D approx. 80 x 330 x 80 mm

Hand blender
SM 384 CB

- Stainless steel cutting blade (rustproof)
- On/off switch (countersunk)
- Powerful 180 watt motor
- Incl. transparent mixing vessel (500 ml)
- Hanging loop

- 220–240 V, 50 Hz, 180 W
- W x H x D approx. 80 x 330 x 80 mm

Hand blender
SM 401 CB

- Soft touch housing
- Stainless steel insert
- 2-level pushbutton switch
- Powerful 600 watt motor
- Stainless steel cutting blade
- Removable stainless steel hand blender
- Ergonomically shaped handle
- Hanging loop

- 220–240 V, 50/60 Hz, 600 W
- W x H x D approx. 65 x 370 x 65 mm



Incl. transparent mixing vessel (500 ml)



Can also be combined as a suitable kitchen set

● Art. no. 603 540
EAN 4 004 470 035 407 PU 12



● Art. no. 603 842
EAN 4 004 470 038 422 PU 8
● Art. no. 603 846
EAN 4 004 470 038 460 PU 8



● Art. no. 604 011
EAN 4 004 470 040 111 PU 6





3in1

Hand blender set SMS 349 CB

- Hand blender set – stainless steel hand blender, multiple chopper and whisk in one
- Working container with scale (0,5 litre)
- Powerful 200 watt motor
- 2 speeds
- Removable metal whisk
- Ergonomically shaped rubberised handle for easier handling
- Holder for metal whisk and stainless steel hand blender
- Incl. mixing vessel with scale (0.7 litre)
- Hanging loop
- 220–240 V, 50/60 Hz, 200 W
- W x H x D approx. 160 x 370 x 150 mm

Spiral cutter ME 470 CB

- Electric spiral cutter for decorative cutting of e.g. carrots, cucumbers, zucchini
- Changeable high-quality drum attachments with stainless steel blade, for quick and easy spiral cutting
- Easy and safe handling thanks to internal cutting unit
- 3 functions
 - fine: 5 mm
 - medium: 10 mm
 - big: 55 mm
- Powerful 80 watt motor
- Large refill opening (ca. Ø 60 mm)
- On/off switch
- Storage for accessories
- Transparent collecting container (dishwasher safe)
- Base station with cord storage
- High stability due to rubberized feet
- Accessories: 3 drum attachments (fine/medium/big), collecting container
- 220–240 V, 50/60 Hz, 80 W
- W x H x D approx. 238 x 380 x 138 mm



27

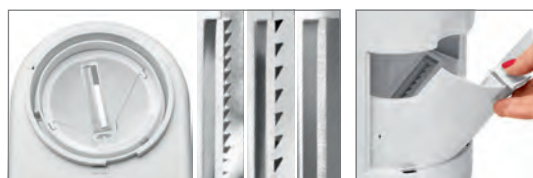

3x drum attachments
with stainless steel
blade (5/10/55 mm)

Storage for accessories

Art. no. 603 491
EAN 4 004 470 034 912

PU 6



Art. no. 604 700
EAN 4 004 470 047 004

PU 4





2in1

Multi chopper & ice-crusher



2in1

Multi chopper & ice-crusher



2in1

Multi chopper & ice-crusher

28

Multi chopper
MZ 449 CB

- Mixing bowl (1 litre capacity)
- Removable chopping blade (rustproof)
- Incl. ice-crusher function
- Safe base
- Easy to clean
- 220–240 V, 50/60 Hz, 250 W
- WxHxD approx. 175 x 220 x 175 mm

Multi chopper
MZ 449 CB

- Mixing bowl (1 litre capacity)
- Removable chopping blade (rustproof)
- Incl. ice-crusher function
- Safe base
- Easy to clean
- 220–240 V, 50/60 Hz, 250 W
- WxHxD approx. 175 x 220 x 175 mm

Multi chopper
MZ 450 CB

- Mixing bowl made of glass (1.2 litre capacity)
- Removable chopping blade (stainless steel, rustproof)
- 2-level pulse switching
- Incl. ice-crusher function
- Safe base
- Easy to clean
- 220–240 V, 50/60 Hz, 300 W
- WxHxD approx. 175 x 265 x 175 mm



Can also be combined as a suitable kitchen set

● **Art. no. 604 490**
EAN 4 004 470 044 904 PU 6



● **Art. no. 604 492**
EAN 4 004 470 044 928 PU 6
● **Art. no. 604 496**
EAN 4 004 470 044 966 PU 6
● **Art. no. 604 498**
EAN 4 004 470 044 980 PU 6



● **Art. no. 604 500**
EAN 4 004 470 045 000 PU 6





Hand mixer
HM 350 CB

- Powerful 250 watt motor
- 5 speed level
- Eject button
- Stainless steel dough hooks and beaters
- All accessories are dishwasher-safe
- 230 V, 50 Hz, 250 W
- WxHxD approx. 180 x 280 x 90 mm

Hand mixer
HM 350 CB

- Powerful 250 watt motor
- 5 speed level
- Eject button
- Stainless steel dough hooks and beaters
- All accessories are dishwasher-safe
- 230 V, 50 Hz, 250 W
- WxHxD approx. 180 x 280 x 90 mm



Can also be combined as a suitable kitchen set

Art. no. 603 500
EAN 4 004 470 035 001 PU 6



Art. no. 603 502
EAN 4 004 470 035 025 PU 6
Art. no. 603 506
EAN 4 004 470 035 063 PU 6





2in1



2in1

Hand mixer set
HM 381 CB

- Powerful 300 watt motor
- 5 speed level
- Turbo setting
- Eject button
- Stainless steel dough hooks and beaters (21 cm) (dishwasher-safe)
- 220–240 V, 50/60 Hz, 300 W
- WxHxD approx. 90 x 145 x 200 mm

Hand mixer set
CB 336

- Powerful 250 watt motor
- 5 speed level
- Turbo setting
- High-speed blender attachment
- With fine steel knife, stainless steel beaters and dough hooks
- Large mixing bowl with automatic drive
- All accessories dishwasher-safe
- 230 V, 50/60 Hz, 250 W
- WxHxD approx. 300 x 350 x 200 mm



Incl. quick blender



Incl. quick blender

● **Art. no. 603 810**
EAN 4 004 470 038 101 PU 6



● **Art. no. 603 360**
EAN 4 004 470 033 601 PU 2



4.7 litre glass dish



1000 Watt



Kneading machine
KM 1393 CB

Kneading machine
KM 1394 CB

- High-performance kneading machine with powerful 1000 watt
 - 8 speed level (0-1-2-3-4-5-6 + pulse function)
 - 5 litre fine steel dish for max. 2.5–3 kg dough preparation
 - Aluminium die-cast stirring hook – also enables the uniform mixing of sizeable quantities of dough
 - Aluminium die-cast dough hook – for heavy doughs, e.g. yeast or bread dough
 - Stainless steel whisk for light sponge cake and fluffy egg whites
 - Special robust gear mechanism
 - Constant power through load-dependent, electronic speed control
 - 35° swivelling multifunction arm
 - Unlocking mechanism for multifunction arm
 - Safety circuit
 - Transparent splash protection lid with refill opening (removable)
 - Particularly easy to operate and clean
 - High stability due to suction feet
 - Quick-action chuck for holding the tools
- 220–240 V, 50/60 Hz, 1000 W
■ WxHxD approx. 356 x 309 x 275 mm

- High-performance kneading machine with 1000 watt
 - 8 speed level (0-1-2-3-4-5-6 + pulse function)
 - 4.7 litre glass dish for max. 2.5–3 kg dough preparation
 - Aluminium die-cast stirring hook – also enables the uniform mixing of sizeable quantities of dough
 - Aluminium die-cast dough hook – for heavy doughs, e.g. yeast or bread dough
 - Stainless steel whisk for light sponge cake and fluffy egg whites
 - Special robust gear mechanism
 - Constant power through load-dependent, electronic speed control
 - 35° swivelling multifunction arm
 - Unlocking mechanism for multifunction arm
 - Safety circuit
 - Transparent splash protection lid with refill opening (removable)
 - Particularly easy to operate and clean
 - High stability due to suction feet
 - Quick-action chuck for holding the tools
- 220–240 V, 50/60 Hz, 1000 W
■ WxHxD approx. 364 x 312 x 284 mm

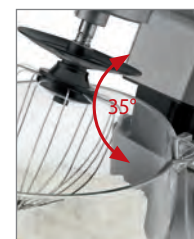

● Art. no. 613 931
EAN 4 004 470 139 310 PU 1
● Art. no. 613 936
EAN 4 004 470 139 365 PU 1

● Art. no. 613 941
EAN 4 004 470 139 419 PU 1





ELECTRONIC

1200 Watt



32

Kneading machine KM 305 CB

- Powerful kneading machine with extra-powerful 1200 watt max.
 - 5 speed level (0-1-2-3-4)
 - 5 LED indicator lights (blue illuminated)
 - 5.6 litre fine steel dish for max. 2.5 kg mixture preparation
 - Stainless steel bowl (rustproof)
 - Aluminium die-cast stirring hook – also enables the uniform mixing of sizeable quantities of dough
 - Aluminium die-cast dough hook – for heavy doughs, e.g. yeast or bread dough
 - Whisk made of stainless steel
 - Special robust gear mechanism
 - Electronic speed control
 - 35° swivelling multifunction arm
 - Unlocking mechanism for multifunction arm
 - Safety circuit (can only be operated with the lid in position or with cover)
 - Transparent splash protection lid
 - Particularly easy to operate and clean
 - High stability due to suction feet
- 220–240 V, 50 Hz, 1200 W max.
 - WxHxD approx. 390 x 350 x 280 mm



Electronic circuit



35° swivelling multifunction arm



Art. no. 603 059
EAN 4 004 470 030 594

PU 1



Art. no. 603 056
EAN 4 004 470 030 563

PU 1





1200 Watt

6.3 litre

35° swivelling
multifunction
arm

Kneading machine KM 398 CB

33

- High-performance kneading machine with extra-powerful 1200 watt
 - 8 speed level (0-1-2-3-4-5-6 + pulse function)
 - 6.3 litre fine steel dish for max. 3–4 kg mixture preparation
 - Aluminium die-cast stirring hook (non-stick coated) – also enables the uniform mixing of sizeable quantities of dough
 - Aluminium die-cast dough hook (non-stick coated) – for heavy doughs, e.g. yeast or bread dough
 - Stainless steel whisk for light sponge cake and fluffy egg whites
 - Special robust gear mechanism
 - 35° swivelling multifunction arm with unlocking mechanism
 - Safety circuit
 - Transparent splash protection lid with refill opening (removable)
 - Particularly easy to operate and clean
 - High stability due to suction feet
 - Quick-action chuck for holding the tools
- 220–240 V, 50 Hz, 1200 W
 - WxHxD approx. 402 x 326 x 212 mm



Art. no. 603 980
EAN 4 004 470 039 801

PU 1

Art. no. 603 986
EAN 4 004 470 039 863

PU 1





Incl. glass mixing container with scale and refill opening (1.5 litre capacity)

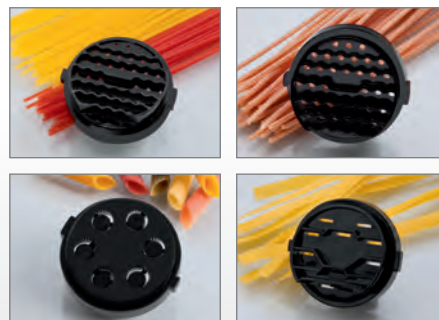

Pasta attachments, e.g. for spaghetti, macaroni, penne and tagliatelle



4in1

1000 Watt

Kneading machine KM 1373 CB

- High-performance kneading machine with powerful 1000 watt
- 8 speed level (0/1/2/3/4/5/6 + pulse function)
- 5 litre fine steel dish for max. 2.5–3 kg dough preparation
- Glass mixing container with scale and refill opening (1.5 litre capacity)
- Aluminium die-cast stirring hook – also enables the uniform mixing of sizeable quantities of dough
- Aluminium die-cast dough hook – for heavy doughs, e.g. yeast or bread dough
- Stainless steel whisk for light sponge cake and fluffy egg whites
- Special robust gear mechanism
- 35° swivelling multifunction arm with unlocking mechanism
- Transparent splash protection lid with refill opening (removable)
- Safety circuit
- Particularly easy to operate and clean
- High stability due to suction feet
- Quick-action chuck for holding the tools

Mincer

- Metal tube, metal cutter, 3 steel mincing disks, stainless steel cutter, sausage filler accessory, biscuit attachment, metal refill tray, attachment for oriental dumplings

Pasta function

- Make pasta yourself with 4 different attachments, e.g. spaghetti, penne, macaroni, tagliatelle

- 220–240 V, 50/60 Hz, 1000 W
- WxHxD approx. 426 x 563 x 230 mm



Accessories: 4 different pasta attachments, metal cutter, metal tube, 3 stainless steel mincing disks, biscuit attachment, sausage filler accessory, kebbe attachment for oriental cuisine



Incl. mincer and pasta function



Glass mixing container with scale and refill opening



XXL
fine steel dish
(6.2 litre)

4in1

1200 Watt



Incl. glass mixing container with scale and refill opening (1.5 litre capacity)



Pasta attachments, e.g. for spaghetti, macaroni and tagliatelle



Kneading machine
KM 1395 CB

- High-performance kneading machine with extra-powerful 1200 watt
- Electronic timer function / LCD display (illuminated in blue)
- Consistent performance due to load-dependent electronic rotation speed control
- 10 speed levels (0/1/2/3/4/5/6/7/8) + pulse function)
- Soft start for slow mixing
- 6.2 litre fine steel dish for max. 3–3.5 kg mixture preparation
- Glas mixing vessel with scale and filling aperture, 1.5 litre
- Aluminium die-cast stirring hook – also enables the uniform mixing of sizeable quantities of dough
- Aluminium die-cast dough hook – for heavy doughs e.g. yeast or bread dough
- Stainless steel whisk for light sponge cake and fluffy egg whites
- Sturdy special gears
- 35° swivelling multifunction arm with unlocking mechanism
- Transparent splash protection lid with filling aperture (detachable)
- Safety circuit
- Particularly easy to operate and clean
- Non-slip stand by suction feet
- Quick-action chuck for holding the tools



LCD display

Mincer

- Metal tube, metal cutter, 3 steel mincing disks, stainless steel cutter, sausage filler accessory, biscuit attachment, metal refill tray, attachment for oriental dumplings

Pastafunction

- Make pasta yourself with 3 different attachments, e.g. spaghetti, macaroni, tagliatelle
- 220–240 V, 50/60 Hz, 1200 W / W x H x D approx. 421 x 336 x 293 mm



Accessories: 3 different pasta attachments, metall cutter, metal tube, 3 stainless steel mincing disks, biscuit attachment, sausage filler accessory, kebbe attachment for oriental cuisine



Incl. mincer and pasta function



Glass mixing container with scale and refill opening



7in1

Food processor
KM 1390 CB

- Powerful food processor with 600 watt
- 4 speed level (0-1-2 + pulse function)
- Mixing vessel with scale and refill opening (1.5 litre capacity)
- Working container with scale and refill opening (1.5 litre capacity)
- Cover for the refill opening can also be used as a measuring beaker (3 cl)
- High-grade, interchangeable attachments from stainless steel for chopping and cutting
- Safety circuit
- Accessories (7in1): Mixing vessel with scale and refill opening (1.5 litre capacity), 1x cutting insert, 1x grating insert, 1x chipping/julienne disc, mixing blade, chopping blade, citrus juicer application, measuring cup (3 cl)
- High stability due to suction feet
- 220-240 V, 50/60 Hz, 600 W
- W x H x D approx. 267 x 385 x 205 mm



Accessories: 1x cutting insert, 1x grating insert, 1x chipping/julienne disc, mixing blade, chopping blade, citrus juicer application



Incl. mixing vessel with scale and refill opening (1.5 litre capacity)



5in1

Stainless steel

Food processor
KM 1382 CB

- Stainless steel housing
- 4 speed level (0-1-2 + pulse function)
- Mixing vessel with scale and refill opening (1.5 litre capacity)
- Working container with scale and refill opening (1.0 litre capacity)
- Cover for the refill opening can also be used as a measuring beaker (3 cl)
- High-grade, interchangeable attachments from stainless steel for cutting and grating
- Safety circuit
- Accessories (5in1): Mixing vessel with scale and refill opening (1.5 litre capacity), stainless steel cutting/grating insert, mixing blade, chopping blade, measuring cup (3 cl)
- High stability due to suction feet
- 220-240 V, 50 Hz, 500 W
- W x H x D approx. 190 x 370 x 190 mm



Accessories: 1x stainless steel cutting/grating insert, mixing blade, chopping blade



Incl. mixing vessel with scale and refill opening (1.5 litre capacity)

Art. no. 613 901
EAN 4 004 470 139 013 PU 2



Art. no. 613 821
EAN 4 004 470 138 214 PU 2





1200 Watt



Mincer FW 447 CB

- Chrome-plated front plate
- Metal neck
- Metal feed tray
- Metal feed screw
- 3 stainless steel discs (7/5/3 mm)
- Stainless steel knife
- Reverse function
- Cookie maker attachment
- Sausage filler accessory
- Kebbe attachment – oriental cuisine
- On/off switch
- High stability due to suction feet
- 220–240 V, 50/60 Hz, 1200 W max.
- W x H x D approx. 330 x 355 x 170 mm



Incl. 3 stainless steel discs, cookie maker attachment, kebbe attachment, sausage filler accessory



Integrated storage compartment for accessories

Universal mixer UM 378 CB

- Universal mixer for pureeing, beating, chopping, shaking and mixing
- Ideal for preparing fruit and fitness drinks, milk shakes, cocktails, soups, salsa sauces, baby food
- Ideal for kitchen and bar
- Ice crush function
- Powerful max. 500 watt motor
- 5 speed level (0-1-2-3-4 + pulse/turbo function)
- Removable mixing bowl (1.5 litre capacity)
- Lid with refill opening
- Cover for the refill opening can also be used as a measuring beaker (2 cl)
- Stainless steel blade (rustproof)
- Safety circuit – operation only possible with vessel in place
- High stability due to rubberized feet
- 220–240 V, 50/60 Hz, 500 W max.
- W x H x D approx. 160 x 400 x 160 mm



Stainless steel

Universal mixer UM 1374 CB

- Stainless steel universal mixer for pureeing, beating, chopping up, shaking and mixing
 - Ideal for preparing fruit and fitness drinks, milk shakes, cocktails, soups, salsa sauces, baby food
 - Ideal for kitchen and bar
 - Stainless steel housing
 - Ice crush function
 - Powerful 650 watt motor
 - 4 speed level (0-1-2-3-4 + pulse function)
 - Removable mixing vessel made of solid glass with 1.5 litre capacity (with scale)
 - Lid with refill opening
 - Cover for the refill opening can also be used as a measuring beaker (6.5 cl)
 - 4-fold stainless steel blade with „piranha“ cut for easy mixing (rustproof)
 - Safety circuit – operation only possible with vessel in place
 - High stability due to rubberized feet
- 220–240 V, 50/60 Hz, 650 W
 - W x H x D approx. 177 x 400 x 175 mm



Mixing cup also suitable as drinking cup

Smoothie maker SM 386 CB

- Universal mixer for pureeing, beating, chopping up, shaking and mixing, consisting of base, mixing cup and lid with drinking aperture
 - “Mix & Go” – Mix your favorite shake in a few minutes. With the practical drinking aperture, you can take your freshly prepared shake with you to work, school or sports
 - Ideal for preparing fruit and fitness drinks, milk shakes, cocktails, soups, salsa sauces, baby food
 - Incl. recipe suggestions
 - Incl. lid with drinking aperture
 - Ideal for kitchen, bar and on the road
 - Powerful motor, 250 W
 - 1 speed (pulse function)
 - Detachable mixing container (600 ml)
 - Stainless steel blade (rustproof)
 - Safety circuit – operation only possible with vessel in place
 - All accessories dishwasher safe
 - High stability due to rubberized suction pads
- 220–240 V, 50 Hz, 250 W
 - W x H x D approx. 130 x 370 x 125 mm

Replacement bottle for Smoothie maker



Art. no. 264 559
EAN 4 006 160 645 590

PU 6



Art. no. 613 741
EAN 4 004 470 137 415

PU 4



Art. no. 603 862
EAN 4 004 470 038 620

PU 6



Art. no. 603 866
EAN 4 004 470 038 668

PU 6





Citrus fruit squeezer
ZP 1092 CB

- Removable bowl with aroma protective cover (1.2 litre)
- 2 press cones
- Automatic start/stop function by pressing juicer cone
- Automatic clockwise/anticlockwise operation for optimal juice extraction
- Practical cable tidy
- 230 V, 50 Hz, 40 W
- WxHxD approx. 180 x 230 x 180 mm



Automatic juicer
AE 1028 CB

- Powerful 400 watt max.
- Fresh fruit and vegetable juices quickly prepared. Rich in vital substances for well-being, fitness and health
- 30% more juice and vitamins
- Removable pulp container
- Removable juice container
- On/off switch
- Lock with safety switch
- Stainless steel micro-strainer for finest juices
- Can be completely taken apart for rapid and unproblematic cleaning
- Safe stand
- 220–240 V, 50 Hz, 350–400 W max.
- WxHxD approx. 235 x 330 x 210 mm



Stainless steel



Stainless steel

Professional automatic juicer AE 1917 CB

- Professional automatic juicer in high-quality stainless steel housing
- Fresh fruit and vegetable juices quickly prepared. Rich in vital substances for well-being, fitness and health
- 30 % more juice and vitamins
- Extra large filler spout (75 mm Ø)
- Extracts the juice from apples, carrots and other fruits within seconds without having to chop them
- Powerful 1000 watt motor max.
- 3 speed levels (0-1-2) for different fruit hardness
- High volume pulp container (approx. 2.0 litre capacity)
- Open stainless steel juice spout
- Drip-stop – no splashes and no wiping
- Lock with safety switch
- Stainless steel sieve for finest juices
- Can be completely disassembled – quick and easy cleaning
- High stability
- 230 V, 50 Hz, 1000 W max.
- WxHxD approx. 300 x 400 x 220 mm



Extra large filler spout
(75 mm Ø)



Drip-stop – no splashes and
no wiping

Automatic juicer AE 1918 CB

- Professional automatic juicer in high-quality stainless steel housing
- Fresh fruit and vegetable juices quickly prepared. Rich in vital substances for well-being, fitness and health
- 30 % more juice and vitamins
- Large filler spout (65 mm Ø)
- 3 speed levels (0-1-2) for different fruit hardness
- Pulp container (approx. 1.5 litre capacity)
- Open juice spout
- Drip-stop due to a folding juice spout
- Lock with safety switch
- Stainless steel sieve for finest juices
- Can be completely disassembled – quick and easy cleaning
- High stability
- 220–240 V, 50/60 Hz, 400 W max.
- WxHxD approx. 272 x 295 x 171 mm



Large filler spout
(65 mm Ø)



Drip-stop due to a
folding juice spout

Art. no. 619 171
EAN 4 004 470 191 714

PU 2



Art. no. 619 181
EAN 4 004 470 191 813

PU 4





Stainless steel

Glass kitchen scale
KW 1515 CB

Kitchen scale
KW 1421 CB

Food dryer
DR 448 CB

- Extra-flat digital kitchen scale
- Weighing surface made of high-quality glass
- Clearly legible LCD display
- Weights up to 5 kg (1 g scaling)
- Adjustable measuring units: g, lb-oz, ml, fl-oz
- Automatic switch-off
- On/off switch
- Tare function (additive weighed function)
- High stability due to rubberized feet
- Low battery indication
- Battery-operated: 1 x CR 2032 (battery supplied)
- W x H x D approx. 150 x 17 x 220 mm

- Extra-flat digital kitchen scales with permanent clock and temperature information
- Stainless steel weighing surface
- Clearly legible, high-quality multifunction LCD display
- Weights up to 5 kg (1 g scaling)
- Adjustable measuring units: kg, g, lb, oz
- Automatic switch-off for weighing function
- On/off switch
- Tare function (additive weighed function)
- Battery-operated: 3 x AAA (batteries supplied)
- W x H x D approx. 160 x 18 x 230 mm

- Food dryer dries fruit, vegetables, herbs, meat etc. Rich in essential minerals for well-being, fitness and health
- 2 temperature stages
- Variable use by 5 large, transparent, and stackable level (easy cleaning)
- Circulation fan, air circulation function
- Overheating protection
- 220-240 V, 50 Hz, 300 W
- W x H x D approx. 330 x 315 x 327 mm



Can also be combined as a suitable kitchen set



Variable use by 5 large, transparent, and stackable levels (easy cleaning)

- Art. no. 615 151
EAN 4 004 470 637 304 PU 6
- Art. no. 615 155
EAN 4 004 470 151 558 PU 6
- Art. no. 615 156
EAN 4 004 470 151 565 PU 6

- Art. no. 614 211
EAN 4 004 470 142 112 PU 6

- Art. no. 604 480
EAN 4 004 470 616 996 PU 4





2in1

Bag sealer FS 1014 CB

- Ideal for dividing food into portions
- Electronically controlled bag sealer
- Seals and separates in one operation
- Strong extraction pump
- With bag storage view window
- 2 indicator lights
- Cord storage in base
- Incl. a roll of film (3 m)

- 220–240 V, 50/60 Hz, 100 W
- WxHxD approx. 330 x 80 x 125 mm

Spare rolls:

Art. no. 8900216

EAN 4 006 160 900 217 PU 10

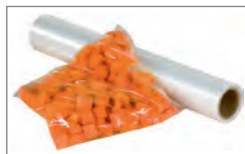

Fondue deep fat pan FFR 1290 CB

- Cool touch housing
- Capacity: 1 litre oil/frying fat
- Deep frying basket with removable handle
- Continuously variable thermostat
- Control panel with display
- 6 fondue forks marked in colour
- Protective ring against spray/fork holder
- Changeable odour and fumes filter
- Overheating protection

- 220–240 V, 50 Hz, 840 W
- WxHxD approx. 190 x 240 x 190 mm



Art. no. 610 140
EAN 4 004 470 101 409 PU 6



Art. no. 612 900
EAN 4 004 470 129 007 PU 4





Deep fat fryer
FR 2223 CB

- Cool touch housing
 - Capacity: approx. 2 litre oil/frying fat
 - Oil container with non-stick coating
 - Large frying basket, can be raised and lowered with the lid closed
 - Pop-up lid with viewing window (detachable)
 - On/off switch (0-1)
 - Continuously adjustable thermostat with indicator light (130 °C–190 °C)
 - 2 indicator lights for power and heating
 - Changeable odour and fumes filter
 - Collecting container for condensation
 - 2 recessed grips for safe transport
- 230 V, 50 Hz, 1800 W
■ WxHxD approx. 245 x 260 x 320 mm



Deep fat fryer
FR 2253 CB

- Stainless steel applications
 - Capacity: 2.5 litre of oil/frying fat
 - Oil container (non-stick coated)
 - Pop-up lid with viewing window (removable)
 - Continuously adjustable thermostat (130 °C–190 °C)
 - 2 indicator lights for temperature/operation
 - Odour and fumes filter
 - Drip tray
 - Carrying handles (heat-insulated)
 - Overheating protection
- 230 V, 50 Hz, 1600 W
■ WxHxD approx. 310 x 230 x 310 mm





 **Stainless steel**



Stainless steel deep fat fryer
FR 2264 CB

- Housing, lid, heating coil made of stainless steel
 - Cool zone technology – heating coils immersed directly in the oil for rapid heating and for odorless frying
 - Capacity: 3 litre of oil/frying fat
 - Continuously adjustable thermostat with indicator light
 - Removable fat container (enamelled)
 - Stainless steel heating coil (removable)
 - Drip tray
 - Carrying handles (heat-insulated)
 - Cord storage
 - Overheating protection
- 230 V, 50 Hz, 2000 W
■ W x H x D approx. 215 x 240 x 405 mm

Hot air fryer
FR 2301 H CB

- Oil and fat free hot air fryer
 - Low smoke or odors
 - Time and energy-saving cooking
 - Cool touch handle
 - Stainless steel inserts
 - Capacity: 2.2 litre
 - Removable container (non-stick coated) with safety switch
 - Continuously adjustable thermostat (80°C–200°C)
 - 60 minute timer with shut-off signal
 - 2 indicator lights for temperature/operation
 - Overheating protection
- 220–240 V, 50/60 Hz, 1500 W
■ W x H x D approx. 265 x 335 x 315 mm

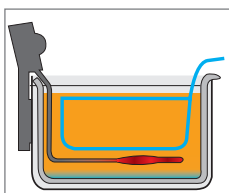

Capacity: 2.2 litre

● **Art. no. 622 641**
EAN 4 004 470 226 416 PU 2



● **Art. no. 623 019**
EAN 4 004 470 230 116 PU 2





2in1



Stainless steel



Jam/marmelade program



Wholemeal program



Jam/marmelade program



Wholemeal program

Rice cooker
RK 2282 CB

Bread maker
CB 594

Bread maker
BBA 566 CB

- Rice cooker and steam cooker in one
- Rice cooker for easy preparation and keeping warm all types of rice, pulses, soups, cereals
- Stainless steel housing
- Additional aluminium steamer insert for vitaminretaining steam cooking of e.g. vegetables, potatoes and fish
- Safety glass lid with steam outlet
- Removable pot (non-stick coating)
- For max. 1300 g of rice (uncooked weight) yields approximately 2500 g cooked rice
- Automatic keep warm mode when cooking has finished
- Automatic switch-off (energy-saving)
- On/off switch
- Cool touch handles
- Removable supply cable
- Safety function: can only be switched on when pot is in position
- 3 indicator lights for cooking, keeping warm and mains
- Accessories: measuring beaker (160 ml max.), rice spoon
- 220–240 V, 50/60 Hz, 700 W
- W x H x D approx. 310 x 310 x 260 mm

- Fully automatic dough and bread preparation (kneading, rising, baking)
- Non-stick coated baking form (removable)
- 3 litre capacity (corresponds to about 1300 g bread)
- 9 baking programs / 31 available settings
- Programs: Normal, french, whole wheat, sweet, dough, cake, sandwich, baking, fast baking
- Marmalade program
- Warming function
- Electronic control panel with LCD display and audible signal
- 13 hour timer
- Variably settable dough quantity
- Variable crust browning control (light, medium, dark)
- Cool touch housing
- Lid with viewing window
- 2 kneading pegs
- Accessories: measuring beaker and spoon
- 230 V, 50 Hz, 800 W
- W x H x D approx. 400 x 290 x 260 mm

- Fully automatic dough and bread preparation (kneading, rising, baking)
- Non-stick coated baking form (removable)
- 2 litre capacity (corresponds to about 1000 g bread)
- 12 baking programs / 39 available settings
- Programs: Normal, french, whole wheat, fast baking, sweet, ultra fast baking I, ultra fast baking II, dough, jam, cake, sandwich, baking
- Marmalade program
- Extra bake function
- Warming function
- Electronic control panel with backlight LCD display
- 13 hour timer
- Variably settable dough quantity
- Variable crust browning control (light, medium, dark)
- Cool touch housing
- Lid with viewing window (removable)
- 230 V, 50 Hz, 600 W
- W x H x D approx. 405 x 305 x 265 mm



Incl. aluminium steamer insert

Art. no. 622 821
EAN 4 004 470 228 212 PU 2

Art. no. 605 940
EAN 4 004 470 059 403 PU 2

Art. no. 605 660
EAN 4 004 470 056 600 PU 2



2in1
**Hot dog maker
& egg boiler**

Steam cooker DG 2286 CB

- Steam cooker for the healthy cooking of food without burning vitamins
 - Water-inflow-control – faster steam generation
 - 3 steam cooker containers, 1 lid, 1 rise bowl
 - High-grade steel base
 - Programmable digital timer
 - Incl. LCD display (blue illuminated)
 - Incl. power control light
 - Drip pan for collecting liquids
 - Water level indicator
 - Add more water during operation
 - Easy to clean
 - Overheating protection
- 220–240 V, 50/60 Hz, 700–800 W
 - WxHxD approx. 310 x 445 x 240 mm



High-grade steel base incl. LCD display / timer with backlight

Hot dog maker HDM 462 EK N CB

- Hot dog maker and egg boiler in one
 - For 1 to 14 small sausages (e. g. "Frankfurter", "Vienna sausages")
 - Heated stainless steel skewer
 - Preparation of up to 6 eggs
 - Removable egg holder
 - Transparent steam tank (removable)
 - Non-stick coated water bowl
 - 2 separate switches for spike and steamer (blue illuminated)
 - Incl. measuring cup with egg pricker
- 230 V, 50 Hz, 380 W
 - WxHxD approx. 235 x 270 x 160 mm



Art. no. 622 861
EAN 4 004 470 228 618

PU 2



Art. no. 604 620
EAN 4 004 470 046 205

PU 6





Stainless steel



Stainless steel

Ceramic coated

Contact grill
KG 2242 CB

- Contact grill for double-sided, fat-free grilling
 - Fat drainage channel and drip tray (tray removable for easy cleaning)
 - 2000 watts
 - Stainless steel housing
 - Continuously adjustable thermostat
 - Short cooking times
 - Non-stick grill plates with extra deep grooves for strong grill pattern and smooth fat drainage
 - Large, heat-insulated handle
 - 2 indicator lights for power supply and heating
 - Temperature "ready" display
 - Large grill area: approx. 29.5 x 23.5 cm
 - Cord storage
 - Versatile, can be used for e.g. panini, steaks, fish or vegetables
- 220–240 V, 50/60 Hz, 2000 W
 - W x H x D approx. 335 x 145 x 335 mm

Contact grill
KG 2284 CB

- Contact grill for double-sided, fat-free grilling
 - Barbecue grill – 180° opening enables grilling on a large surface
 - Fat drainage channel and drip tray (tray removable for easy cleaning)
 - 2000 watt
 - Stainless steel housing
 - Continuously adjustable thermostat
 - Short cooking times
 - Scratch-resistant, ceramic coated grill plates with extra deep grooves for strong grill pattern and optimal fat runoff
 - Large, heat-insulated handle
 - 2 indicator lights for power supply and heating
 - Temperature "ready" display
 - Large grill areas: 2x approx. 29.5 x 23.5 cm
 - Cord storage
 - Versatile, can be used for e.g. panini, steaks, fish or vegetables
- 220–240 V, 50/60 Hz, 2000 W
 - W x H x D approx. 356 x 145 x 336 mm



Stainless steel housing



Scratch resistant ceramic coating



Stainless steel housing



Barbecue grill – 180° opening enables grilling on a large surface

Art. no. 622 421
EAN 4 004 470 224 214

PU 3



Art. no. 622 840
EAN 4 004 470 228 403

PU 3





Ceramic coated



Party pan
PP 2233 C CB

- Party pan for cooking, roasting, steaming, defrosting and with keep warm function
- Quick heating and long keep warm function
- Removable supply line with continuously adjustable thermostat
- Ceramic coated pan (scratch-proof and easy to clean)
- Ø 32 cm, depth: 3.5 cm
- Heat-resistant glass lid with handle
- Heat-insulated carrying handle

- 220–240 V, 50/60 Hz, 1500 W
- WxHxD approx. 380 x 160 x 400 mm

Raclette grill
RG 2247 CB

- Cool touch housing
- For grilling and browning
- Removable grill plate
- 8 pans
- 8 wooden spatulas
- Continuously adjustable thermostat
- Indicator light
- Non-stick coating on the grill plates and pans (easy to clean)
- Grill area: approx. 40.5 x 30 cm
- Safe base due to rubberized feet

- 220–240 V, 50/60 Hz, 1200–1400 W
- WxHxD ca. 430 x 130 x 340 mm



Scratch resistant ceramic coating



8 wooden spatulas

● Art. no. 622 332
EAN 4 004 470 223 323 PU 2



● Art. no. 622 471
EAN 4 004 470 224 719 PU 3





2 in 1 Raclette grill
RG 2279 CB

- Cool touch housing
 - For grilling and browning
 - Turning iron plate – Combination grill area for grilling fish (smooth surface) or meat (extra deep grooves for an intense grill pattern)
 - Natural grill stone for a healthy, low-fat grilling
 - Total grill area: ca. 46 x 23 cm (2x ca. 23 x 23 cm)
 - 8 pans, 8 wooden spatula
 - Continuously adjustable thermostat (blue illuminated)
 - Non-stick coating on the grill plates and pans (easy to clean)
- 220–240 V, 50/60 Hz, 1200–1400 W
■ W x H x D approx. 465 x 150 x 235 mm



Barbecue standing grill
BQS 2244 CB

- Stand grill in an attractive design with low smoke emission and low smell
 - Continuously adjustable thermostat with indicator light
 - Chromed grill grid
 - Removable grill and heating elements for easy cleaning
 - Cool touch housing
 - Metal drip tray
 - Wind protection (removable)
 - Additional tray
 - Can be converted to a table grill
 - Grill height: approx. 80 cm
 - Grilling surface: 35.5 x 24.5 cm
- 230 V, 50 Hz, 2000 W
■ W x H x D approx. 510 x 820 x 370 mm



Natural grill stone for a healthy, low-fat grilling



Continuously adjustable thermostat (illuminated in blue)



Combination grill area for grilling fish or meat (turning iron plate)



Art. no. 622 791
EAN 4 004 470 227 918

PU 2



Art. no. 622 441
EAN 4 004 470 224 412

PU 4





Barbecue table grill
BQ 2243 CB

- Table grill in an attractive design with low smoke emission and low smell
- Continuously adjustable thermostat with indicator light
- Chromed grill grid
- Removable grill and heating elements for easy cleaning
- Cool touch housing
- Metal drip tray
- Wind protection
- Grilling surface: 36 x 25 cm

- 230 V, 50 Hz, 2000 W
- WxHxD approx. 510 x 145 x 370 mm

Barbecue table grill
BQ 1240 N CB

- Table grill in an attractive design without fire and smoke
- Cool touch housing
- On/off switch with indicator lamp
- Removable grill and heating elements for easy cleaning
- Metal drip tray
- Grilling surface: 35.5 x 24.5 cm

- 230 V, 50 Hz, 2000 W
- WxHxD approx. 480 x 100 x 360 mm



3in1

Doner, chicken and shashlik grill



Convection oven
HLO 2280 CB

NEW! Doner vertical multigrill
DVG 3006 CB

- Gentle cooking by circulating hot air, low-fat and vitamin-preserving
- Many different uses for baking, roasting, grilling, steaming, braising, defrosting, heating, barbecuing (easy to use)
- Halogen heating element for faster heating
- Saves time and energy: requires up to 45 % less energy than a conventional oven
- Ideal for small kitchens and mobile use
- Continuously adjustable thermostat from 0–200 °C
- 12 litre interior
- Glass bowl: Ø 33 cm
- Container made of safety glass – heat and scratch-resistant (dishwasher-safe)
- 60 minute timer with alarm when cooking is completed
- Indicator lights for operation and temperature
- Safety switch, practical safety handle
- Heat-insulated carrying handles
- Accessories: upper and lower grid, steamer insert, tongs, skewers, lid holder

- 220–240 V, 50/60 Hz, 1200–1400 W
- W x H x D approx. 380 x 335 x 355 mm

- Vertical Kebab Multigrill for fat-free grilling of chickens, kebab/gyros or meat skewers
- Thanks to its vertical position, escaping jus drips directly into the stainless steel fat tray
- Incl. 1 rotary spit (large) for chickens or kebab/gyros
- Incl. 6 separately rotating meat skewers (small)
- Incl. stainless steel tong
- On/off switch
- Indicator light

- 220–240 V, 50/60 Hz, 1400 W
- W x H x D approx. 255 x 350 x 255 mm



Lower/upper grid



Steamer insert



1 rotary spit (large) for chickens or kebab/gyros



6 separately rotating meat skewers (small)

Art. no. 622 800
EAN 4 004 470 228 007

PU 1



Art. no. 630 061
EAN 4 004 470 300 611

PU 2





Mini oven
MB 2245 CB

- 8 litre capacity
- Top and bottom heat
- 15 minute timer
- 2 quartz heating elements
- Pull-out grill grid
- Baking tray
- Drawer for crumbs
- Overheating protection

- 220–240 V, 50/60 Hz, 800 W
- WxHxD approx. 365 x 220 x 250 mm

Multi pizza oven
MPO 2246 CB

- Pizza oven ideal for grilling and crisping up
- Large grill, ideal for pizza (26 x 25 cm)
- Including baking tray (23.5 x 22 cm)
- Capacity: approx. 12 litre
- Top and bottom heat (combined operation possible)
- 4-step switch (top heat, bottom heat, top and bottom heat combined, off)
- 2 quartz heating elements
- 60 minute timer with end signal
- Stainless steel handle
- Crumb tray
- Overheating protection

- 220–240 V, 50/60 Hz, 1000 W
- WxHxD approx. 375 x 220 x 330 mm



Incl. baking tray (23.5 x 22 cm)

● Art. no. 622 451
EAN 4 004 470 224 511 PU 4



● Art. no. 622 461
EAN 4 004 470 224 610 PU 4





2in1

Microwave MW 2288 CB

- 700 watt microwave
- 20 litre oven capacity
- 6 level
- Rotating plate, Ø approx. 24.5 cm
- 30 minute timer with end signal
- Oven light
- Large viewing window
- 230–240 V, 50 Hz, 1200 W
- W x H x D approx. 455 x 265 x 340 mm

Microwave with grill MWG 2289 CB

- 700 watt microwave
- 900 watt grill
- 20 litre oven capacity
- 5 microwave power level
- 3 levels in combined operation (grill/microwave)
- 1 grill level
- Rotating plate: Ø approx. 24.5 cm
- Cooking grid: Ø approx. 20.0 cm
- 30 minute timer with end signal
- Oven light
- Large viewing window
- 230–240 V, 50 Hz, 1200 W
- W x H x D approx. 455 x 265 x 340 mm

● Art. no. 622 880
EAN 4 004 470 228 809 PU 1
● Art. no. 622 889
EAN 4 004 470 228 892 PU 1



● Art. no. 622 890
EAN 4 004 470 228 908 PU 1
● Art. no. 622 899
EAN 4 004 470 228 991 PU 1





2in1



ELECTRONIC



3in1

Convection

54

NEW!

Microwave with grill
MWG 2270 CB

- 700 watt microwave
 - 1000 watt grill
 - 20 litre capacity
 - 5 microwave power level
 - 2 level in combined operation grill/microwave
 - 1 grill level
 - 9 automatic programs incl. defrost program
 - Quick-start program
 - Timer function with up to 24 h time delay
 - Rotating plate: Ø approx. 25.5 cm
 - Grilling grid: Ø approx. 20.0 cm
 - 95 minute timer with end signal
 - Quartz heating element
 - Easy Tronic
 - Digital clock
 - Child lock
 - Oven light
 - Large viewing window
- 230 V, 50 Hz, 1050 W
 - W x H x D approx. 440 x 260 x 370 mm

Microwave with grill and convection
MWG 2285 H CB

- Stainless steel front
 - 800 watt microwave power
 - 1350 watt grill
 - 1350 watt convection
 - Quick-start program
 - 20 litre capacity
 - 11 microwave power level
 - 2 level in combined operation (grill/microwave)
 - 4 level in combined operation (convection/microwave)
 - 1 grill level
 - 10 temperature settings for convection
 - 9 automatic programs incl. defrost program
 - Rotating plate, Ø approx. 24.5 cm
 - Grilling grid, Ø approx. 20.0 cm
 - 95 minute timer with end signal
 - Quartz heating elements
 - Digital clock
 - Child lock
 - Oven light
- 230–240 V, 50 Hz, 1200 W
 - W x H x D approx. 455 x 262 x 375 mm



Art. no. 622 704

EAN 4 004 470 227 048

PU 1



Art. no. 622 706

EAN 4 004 470 227 062

PU 1



Art. no. 622 851

EAN 4 004 470 228 519

PU 1





3in1

Convection

Stainless steel

4in1

Stainless steel

Convection

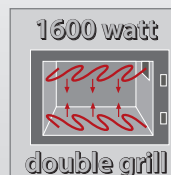

Microwave with grill and convection
MWG 2281 H CB

Double-grill microwave
MWG 2218 H CB

- Stainless steel housing
- Reflecting glass front
- 800 watt microwave
- 1200 watt grill
- 1200 watt convection
- 23 litre capacity
- 5 microwave power level
- 2 level in combined operation (microwave/grill)
- 10 level in combined operation (microwave/convection)
- 1 grill level
- 10 temperature settings for convection
- 10 automatic programs
- 2 defrost programs
- Rotating plate, Ø approx. 27.0 cm
- Grilling grid, Ø approx. 21.0 cm
- 95 minute timer with end signal
- Quartz heating elements
- Digital clock
- Child lock
- Oven light

- 230 V, 50 Hz, 1300 W
- W x H x D approx. 485 x 295 x 405 mm

- Stainless steel housing
- Stainless steel interior
- Double grill for, for example, crispy pizza, baguettes, soufflés, etc. (1100 watt top heat, 500 watt lower heat)
- 900 watt microwave
- 1600 watt double grill
- 2500 watt convection
- Quartz top heating element
- 25 litre capacity
- 5 microwave power levels
- 10 temperature settings convection
- 10 automatic programs
- Defrost program
- Quick-start program
- Incl. pizza program and pizza stone, Ø approx. 30.0 cm
- Incl. enameled rotating plate, dishwasher-safe and scratchproof, Ø approx. 30.0 cm
- Grilling grid, Ø approx. 25.0 cm
- 95 minute timer with end signal
- Start delay
- Digital clock
- Child lock
- Oven light

- 230 V, 50 Hz, 1500 W
- W x H x D approx. 510 x 300 x 430 mm



Pizza function incl. pizza stone





**Stand-alone/
Under-cabinet mounting**



56

**Combined microwave oven with grill
MWG 2211 U CB**

**Built-in microwave with grill
MWG 2215 EB**

- Stainless steel front
- 800 watt microwave
- 1000 watt grill
- 20 litre capacity
- 5 microwave power level
- 2 level in combined operation
- 1 grill level
- 8 automatic programs
- Defrost programs, selectable according to time and weight
- Quick-start program
- Rotating plate, Ø approx. 24.5 cm
- Grilling grid, Ø approx. 21.0 cm
- 95 minute timer with end signal
- Easy Tronic, digital clock, child lock
- Oven light
- Large viewing window
- Can be positioned as required or used as a built-under appliance (incl. installation material)
- 230 V, 50 Hz, 1250 W
- WxHxD approx. 460 x 285 x 370 mm

- Built-in microwave with frame
- Stainless steel front, stainless steel interior
- 800 watt microwave
- 1000 watt grill
- 5 microwave power level
- 2 level in combined operation (grill/microwave)
- 1 grill level
- 8 automatic programs
- Defrost programs, selectable according to time and weight
- 20 litre capacity
- Rotating plate, Ø approx. 24.5 cm, grilling grid, Ø approx. 21 cm
- 95 minute timer with end signal
- Start delay
- Child lock
- Oven light



Built-under appliance

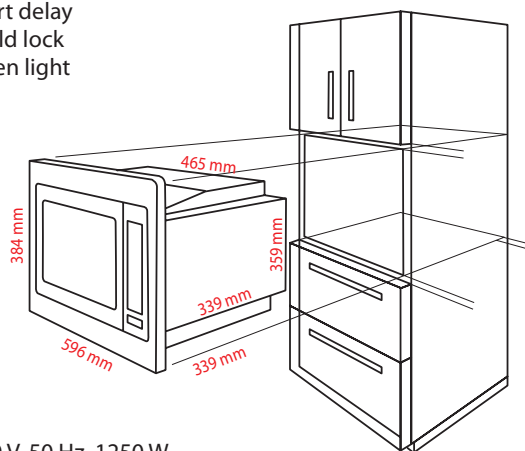

- 230 V, 50 Hz, 1250 W
- Appliance (WxHxD): 465 x 359 x 339 mm
- Appliance with frame (WxHxD): 596 x 384 x 339 mm
- Weight: approx. 14 kg

● **Art. no. 622 111**
EAN 4 004 470 221 114 PU 1



● **Art. no. 622 151**
EAN 4 004 470 221 510 PU 1



3in1



Built-in microwave with grill and convection
MWG 2216 H EB

- Built-in microwave with frame
- Stainless steel front, stainless steel interior
- 900 watt microwave
- 1100 watt grill
- 2500 watt convection function
- 5 microwave power level
- 2 level in combined operation (grill/microwave)
- 2 level in combined operation (convection/microwave)
- 1 grill level
- 10 temperature settings for convection (130°C–220°C)
- 10 automatic programs
- 2 defrost programs, 1 quick-start program
- 25 litre capacity
- Rotating plate, Ø approx. 32.0 cm, grilling grid, Ø approx. 26.0 cm
- 95 minute timer with end signal
- Start delay
- Child lock
- Oven light

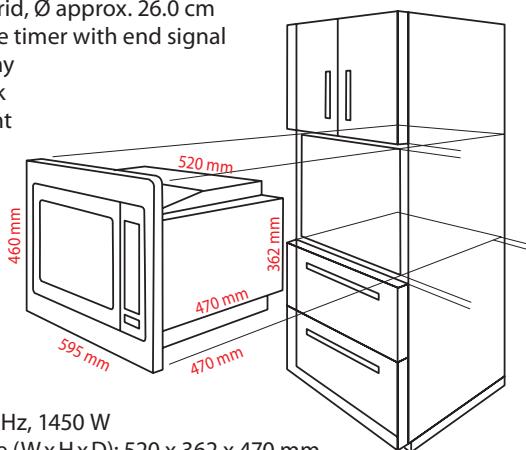

- 230 V, 50 Hz, 1450 W
- Appliance (W x H x D): 520 x 362 x 470 mm
- Appliance with frame (W x H x D): 595 x 460 x 470 mm
- Weight: approx. 21 kg

3in1



NEW! Built-in microwave with grill and convection MWG 3001 H EB

- Built-in microwave in frameless design
- Stainless steel front, stainless steel interior
- LCD display / Digital clock
- 900 watt microwave
- 1000 watt grill
- 2300 watt convection function
- 5 microwave power level
- 2 level in combined operation (grill/microwave)
- 2 level in combined operation (convection/microwave)
- 1 grill level
- 5 temperature settings for convection (100°C–200°C)
- 8 automatic programs
- Defrost program, quick-start program
- Timer function with up to 24 h time delay
- 25 litre capacity
- Rotating plate, Ø approx. 27.0 cm, grilling grid, Ø approx. 22.2 cm
- 60 minute timer with end signal
- Child lock
- Oven light

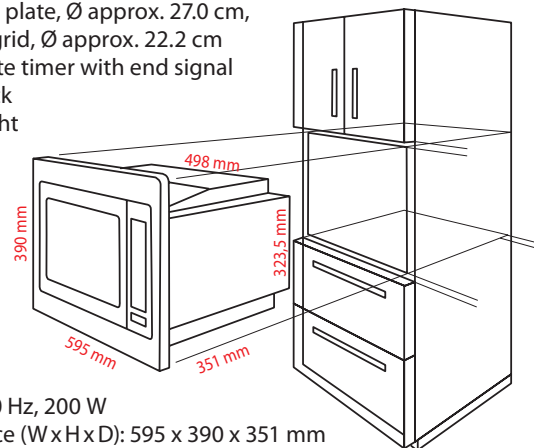

- 230 V, 50 Hz, 200 W
- Appliance (W x H x D): 595 x 390 x 351 mm
- Weight: approx. 17 kg





Stainless steel

58

Stainless steel double hotplate DKP 5033 E CB

- Stainless steel housing
- 2 hotplates
 - 1 x Ø approx. 180 mm, 1500 watt
 - 1 x Ø approx. 150 mm, 1000 watt
- 2 continuously variable thermostats
- 2 indicator lights
- Incl. 2 mountable cool touch handles
- High stability
- 230 V, 50 Hz, 2500 W
- W x H x D approx. 590 x 70 x 280 mm (with handles)

Single hotplate EKP 5027 CB

- Hotplate, Ø approx. 180 mm, 1500 watt
- Infinitely adjustable thermostat
- Indicator light
- Heat-resistant finish
- High stability
- 230 V, 50 Hz, 1500 W
- W x H x D approx. 360 x 70 x 285 mm

Double hotplate DKP 5028 CB

- 2 hotplates
 - 1 x Ø approx. 180 mm, 1500 watt
 - 1 x Ø approx. 150 mm, 1000 watt
- 2 continuously variable thermostats
- 2 indicator lights
- Heat-resistant finish
- High stability
- 230 V, 50 Hz, 2500 W
- W x H x D approx. 570 x 70 x 285 mm



Art. no. 650 331
EAN 4 004 470 503 319

PU 3



Art. no. 650 270 (EKP 5027 CB)

EAN 4 004 470 502 701 PU 4



Art. no. 650 280 (DKP 5028 CB)

EAN 4 004 470 502 800 PU 3





Single induction hotplate EKI 5026 CB

- Induction hotplate with high-quality, eco-friendly glass-ceramic-surface
- Heating only takes seconds thanks to induction technology
- Scratch-resistant smooth cooking area, very easy to clean
- ECO-Save – 55 % time savings compared to conventional cooking plates, no preheating phase, energy saving
- Automatic pot detection – automatic switch-off in the case of non-induction pots
- 10 power level and 10 temperature level with LED indication (60° C – 240° C)
- Electronic sensor touch control panel with display for comfortable operation
- 3 LED indicator lights
- 180 minute timer with automatic switch-off and end signal
- Countdown indication
- Automatic switch-off after 120 min. without operation
- Automatic switch-off after removal of the pot
- Child lock
- High stability due to non-slip feet
- 220–240 V, 50/60 Hz, 2000 W
- W x H x D approx. 290 x 65 x 370 mm

Single induction hotplate EKI 5014 CB

- Induction hotplate with high-quality, eco-friendly Schott-Ceran® glass-ceramic surface
- Heating only takes seconds thanks to induction technology
- Scratch-resistant smooth cooking area, very easy to clean
- ECO-Save – 55 % time savings compared to conventional cooking plates, no preheating phase, energy-saving
- Automatic pot detection – automatic switch-off in the case of non-induction pots
- 10 power level and 10 temperature level
- Electronic control panel with display
- Easy to handle because of oversized buttons
- Power indication on LED display
- 180 minute timer with automatic switch-off and end signal
- Automatic switch-off after 120 min. without operation
- Automatic switch-off 15 sec. after removal of the pot
- 7 LED indicator lights
- High stability due to non-slip feet
- 230 V, 50 Hz, 2000 W
- W x H x D approx. 280 x 65 x 360 mm



MC 701 CB



MC 702 CB



Textile cleaner MC 701 CB / MC 702 CB

MC 701 CB

- Ideal for the easy removal of lint/pilling
- Handy size
- Metal lint grid
- Transparent lint container
- On/off switch

- Battery operation: 2x 1.5 V (AA) (batteries not included)
- W x H x D approx. 36 x 76 x 76 mm

MC 702 CB

- Ideal for the easy removal of lint/pilling
- Handy size
- Metal lint grid
- Transparent lint container
- On/off switch

- Battery operation: 2x 1.5 V (AA) (batteries not included)
- W x H x D approx. 60 x 85 x 170 mm

●	Art. no. 607 010 (MC 701 CB)	
	EAN 4 004 470 070 101	PU 20
●	Art. no. 607 020 (MC 702 CB)	
	EAN 4 004 470 070 200	PU 20





Steam iron DB 785 CB

- Special stainless steel sole plate
 - Steam jet function, spray device and vertical steam
 - Variable temperature control
 - Continuous steam regulation
 - Dry function (steam can be switched off)
 - Practical self-cleaning function
 - Transparent water container (approx. 135 ml)
 - Cable attached via 360° turnable joint
 - Indicator light
- 220–240 V, 50/60 Hz, 1700 W
■ WxHxD approx. 110 x 140 x 260 mm

Steam iron DB 765 CB

- Special stainless steel sole plate
 - Steam jet function, spray device and vertical steam
 - Variable temperature control
 - 3-level steam control
 - Dry function (steam can be switched off)
 - Practical self-cleaning function
 - Transparent water container (approx. 130 ml)
 - Cable attached via 360° turnable joint
 - Indicator light
- 230 V, 50 Hz, 2000 W
■ WxHxD approx. 115 x 155 x 275 mm

Steam iron DB 780 CB

- Special stainless steel sole plate
 - Steam jet function, spray device and vertical steam
 - Variable temperature control
 - Continuous steam regulation
 - Dry function (steam can be switched off)
 - Practical self-cleaning function
 - Transparent water container (approx. 200 ml)
 - Cable attached via 360° turnable joint
 - Indicator light
- 220–240 V, 50/60 Hz, 2200 W
■ WxHxD approx. 110 x 150 x 275 mm



Ceramic

Ceramic

Steam iron DB 784 CB

- Special stainless steel sole plate
 - 7 functions:
 - Spray device
 - Steam jet function
 - Vertical steam
 - Dry function (steam can be switched off)
 - Self-cleaning function (switchable)
 - Anti-drip function
 - Anti-calc system
 - Variable temperature control
 - Continuous steam regulation
 - Transparent water container (approx. 360 ml)
 - Cable attached via 360° turnable joint
 - Indicator light
- 220–240 V, 50/60 Hz, 2500 W
 ■ WxHxD approx. 115 x 150 x 290 mm

Steam iron DB 781 CB

- Scratch-resistant ceramic sole plate with outstanding sliding behaviour
 - 5 functions:
 - Spray device
 - Steam jet function
 - Vertical steam
 - Dry function (steam can be switched off)
 - Self-cleaning function (switchable)
 - Variable temperature control
 - Continuous steam regulation
 - Transparent water container (approx. 250 ml)
 - Cable attached via 360° turnable joint
 - Indicator light
 - Measuring cup
- 220–240 V, 50/60 Hz, 1800–2200 W
 ■ WxHxD approx. 118 x 134 x 280mm

Steam iron DB 782 CB

- Scratch-resistant ceramic sole plate with outstanding sliding behaviour
 - 7 functions:
 - Spray device
 - Steam jet function
 - Vertical steam
 - Dry function (steam can be switched off)
 - Self-cleaning function (switchable)
 - Anti-drip function
 - Anti-calc filter system
 - Variable temperature control
 - 4-level steam control (0-1-2-3)
 - Transparent water container (approx. 360 ml)
 - Rubberised handle for non-slip handling
 - Rubberised rest for excellent stability
 - Cable attached via 360° turnable joint
 - Indicator light
- 220–240 V, 50/60 Hz, 2400–2800 W
 ■ WxHxD approx. 120 x 160 x 300 mm



Easy-running, scratch-resistant ceramic sole plate



Easy-running, scratch-resistant ceramic sole plate

● Art. no. 607 841
 EAN 4 004 470 078 411 PU 6



● Art. no. 607 810
 EAN 4 004 470 078 107 PU 6



● Art. no. 607 820
 EAN 4 004 470 078 206 PU 6





Ceramic

NEW! Steam ironing unit DBS 1796 CB

- Special stainless steel sole plate
 - Constantly high heat resistance and optimal steam generation
 - Continuous steam regulation approx. 10–50 g
 - Even and consistent heat distribution through 13 spray nozzles
 - Horizontal and vertical steam jet function
 - Constant high steam output: max. 50 g/min.
 - Removable water tank (1.0 litre capacity), in case of average operation sufficient for approx. 80 minutes
 - Permanent refill function – refilling of the water tank during the operation possible
 - On/off switch (illuminated)
 - 3 indicator lights for:
 - Water refill
 - Steam ready
 - Heating
 - Continuously adjustable temperature control
 - Extra large rest plate to provide the iron with a stable rest
 - Long connection cable
 - Cable take-up
- 230 V, 50 Hz, 2000 W
 ■ WxHxD approx. 230 x 320 x 420 mm



Removable water tank
(1.0 litre capacity)

NEW! Steam ironing unit DBS 1797 CB

- Scratch-resistant ceramic sole plate with outstanding sliding behaviour
 - Constantly high heat resistance and optimal steam generation
 - Continuous steam regulation approx. 10–50 g
 - Even and consistent heat distribution through 13 spray nozzles
 - Horizontal and vertical steam jet function
 - Constant high steam output: max. 50 g/min.
 - Removable water tank (1.0 litre capacity), in case of average operation sufficient for approx. 80 minutes
 - Permanent refill function – refilling of the water tank during the operation possible
 - On/off switch (illuminated)
 - 3 indicator lights for:
 - Water refill
 - Steam ready
 - Heating
 - Continuously adjustable temperature control
 - Extra large rest plate to provide the iron with a stable rest
 - Long connection cable
 - Cable take-up
- 230 V, 50 Hz, 2000 W
 ■ WxHxD approx. 230 x 320 x 420 mm



Removable water tank
(1.0 litre capacity)



Scratch resistant ceramic sole plate with outstanding sliding behaviour



Steam cleaner
DR 907 CB

- Steam cleaner, cleans, disinfects and degreases without limescale residues and cleaning strip
- 3.5 bar max. steam pressure
- Approx. 250 ml water tank
- Extra-long cable (approx. 5.0 m)
- Overpressure protection
- Overheating protection
- Incl. 9 accessories: brush, angle, fleece, window cleaner and universal cleaning attachment, 360° swiveling steam nozzle, hose, measuring cup, funnel
- 220–240 V, 50/60 Hz, 900–1050 W
- WxHxD approx. 250 x 225 x 135 mm

Steam cleaner
DR 906 CB

- Steam cleaner, cleans, disinfects and degreases without limescale residues and cleaning strip
- 3.5 bar max. steam pressure
- Approx. 600 ml water tank
- Aluminum boiler
- Indicator light (mains and standby)
- Safety tank lid with pressure relief valve
- Overheating protection
- On/off switch protected against water spray
- Practical carrying handle
- Smooth-running wheels
- Steam control on the handle
- Incl. 9 accessories: 2-part extendable insertable tube, floor brush, non-woven cloth, window wiper, jet nozzle attachments, round brush attachment, funnel, measuring beaker
- 230 V, 50/60 Hz, 1350 W
- WxHxD approx. 230 x 310 x 320 mm



Round brush attachment



Incl. 360° swiveling steam nozzle



Universal cleaning attachment



Angle attachment



Fleece



Measuring cup



Extendable insertable tube



Floor brush



Round brush attachment



Window wiper



Angle attachment

● Art. no. 609 079
EAN 4 004 470 090 796 PU 6



● Art. no. 609 061
EAN 4 004 470 090 611 PU 1





Fleece attachment for thorough cleaning



Window-cleaning attachment, cleans without streaks and limescale residue



Accessories: 2x microfiber cloth, measuring beaker, window cleaner, nozzle, brush, carpet glider attachment

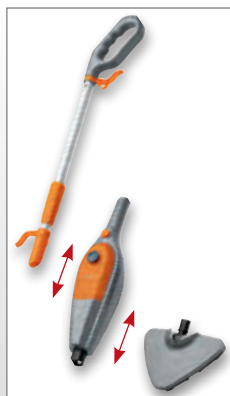

Space-saving storage by easy separation of the components



Steam mop
DR 904 CB

Battery vacuum cleaner
CB 967



- Steam cleaner cleans, disinfects and removes grease at 100 °C without grease marks and residues
 - Suitable for different surfaces: e.g. laminates, wooden floors, marble, rubber, slate, ceramics
 - Cleans fabric surfaces such as carpets, mats and cushions
 - Environmentally friendly and hygienic cleaning without the use of chemicals
 - Kills bacteria through high steam power
 - Maximum disinfection and intensive cleaning
 - Ready to use in around 30 seconds
 - Approx. 300 ml water tank
 - Use for up to 30 min. on a full tank
 - Up to 25 g steam/min.
 - Carpet glider attachment
 - Aluminium telescopic tube
 - Removable handle and nozzle for easy use by hand
 - Accessories: 2x microfiber cloth, measuring beaker, window cleaner, nozzle, brush
 - Long lead, approx. 5.0 m
 - Electric lead take-up
 - Fire protection fuse
- 220–240 V, 50/60 Hz, 1500 W
 - W x H x D approx. 260 x 1200 x 210 mm

- With 3 rechargeable Ni-Mh batteries
 - Nozzle for small gaps, brush nozzle
 - Permanent dust filter, washable
 - Charge control lamp (LED)
 - Charger mains adapter
 - Foot/wall mounting (installation materials not supplied)
- Charger mains adapter: 230 V, 50 Hz
 - Rechargeable battery: 3.6 V, 1400 mAh
 - W x H x D approx. 100 x 130 x 310 mm



Art. no. 609 041
EAN 4 004 470 090 413

PU 3



Art. no. 609 670
EAN 4 004 470 096 705

PU 6





Battery wet/dry vacuum cleaner AKS 960 CB

- Wet/dry vacuum cleaner
- Powerful battery vacuum cleaner with three rechargeable batteries
- Permanent dust filter, washable
- Charge indicator light (LED)
- Charger mains adapter
- Accessories: Recess nozzle, attachment for wet vacuuming, wall mounting
- Charger mains adapter: 230 V, 50 Hz
- Rechargeable battery: 3.6 V, 1400 mAh
- WxHxD approx. 110 x 130 x 380 mm



Battery vacuum cleaner AKS 713 CB

- Wet/dry vacuum cleaner
- Powerful battery vacuum cleaner with 10 rechargeable batteries
- Permanent dust filter (washable)
- Charge control lamp (LED)
- 12 V and battery operation possible
- Direct-Drive function: with fully discharged battery, the vacuum cleaner can be used immediately in 12 V operation
- Cable storage compartment
- Accessories: 2x crevice nozzle (1x 13 cm, 1x 26 cm), attachment for wet vacuuming, brush nozzle, 12 V adapter cable
- Charger mains adapter: 230 V, 50 Hz
- Rechargeable battery: 12 V / Battery (NiMh), 1400 mAh
- WxHxD approx. 125 x 130 x 400 mm

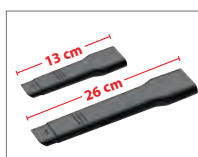

Extra-long crevice nozzles, for example, for use in the car



Attachment for wet vacuuming



360° brush nozzle

Hand vacuum cleaner CB 947

- Hand vacuum cleaner for vacuuming of: furniture, upholstery, frames, curtains, books, computers, cars, and much more
- Compact size: 24 x 12 x 15 cm
- Permanent dust filter
- Easy to clean
- Large operation range (6 m cable)
- Low weight
- Vertical storage (space saving)
- Accessories: flexible „vacuum snout“ with crevice nozzle, small and large brush, shoulder strap
- 230 V, 50 Hz, 700 W max.
- WxHxD approx. 110 x 185 x 360 mm



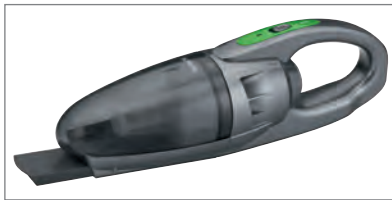

Incl. battery vacuum cleaner



Charging station suitable for wall mounting



Space-saving folding handle



2in1



Incl. electrically rotating turbo floor brush



LED front light for better illumination of dark areas



Incl. flexible brush for corners and edges



2-fold accessories: combined brush/crevice nozzle

2in1

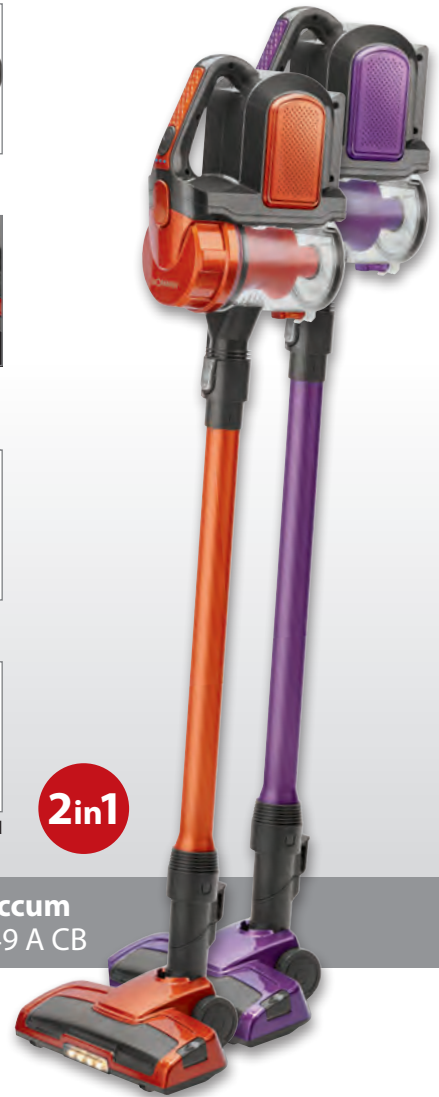

Battery floor vacuum cleaner BS 1714 A CB

Battery floor vacuum cleaner BS 1949 A CB



- Accu-hand and floor vacuum cleaner, for flexible and individual operations as brush-/hand vacuum cleaner
 - Permanent dust filter (washable)
 - Powerful 12 V, 1800 mAh Accus
 - LED charge level indicator (illuminated)
 - 12 V and battery operation possible
 - Cable free (for flexible use)
 - 180° rotatable double joint for optimal mobility
 - Bagless filter technology
 - Incl. telescopic crevice nozzle and electrical, rotating turbo floor brush
 - Charging station suitable for wall mounting (incl. mounting material)
 - Space-saving folding handle
- Charger mains adapter: 100–240 V, 50/60 Hz
 - Rechargeable battery: 12 V, 1800 mAh
 - W x H x D approx. 130 x 1120 x 270 mm (extended)



- Accu-hand and floor vacuum cleaner, for flexible and individual operations as brush-/hand vacuum cleaner
 - Bagless Cyclon Twin Spin technique allows continual high suction power
 - Bagless filter technology
 - Powerful lithium-ion battery 21,6 V, 2200 mAh accu
 - Running time approx. 30 min
 - 2 suction levels (turbo function electrically switchable)
 - LED battery charge condition indicator (illuminated)
 - Cable free (for flexible use)
 - HEPA-Filter
 - Aluminium suction tube
 - Easy to clean
 - Low weight
 - Charging station suitable for wall mounting (incl. mounting material)
 - Incl. electrically rotating turbo floor brush with LED front light for better illumination of dark areas
 - Incl. flexible brush for corners and edges
 - Accessories: aluminium suction tube, wall mount, special brush, combined brush/crevice nozzle
- Charger mains adapter: 230–240 V, 50 Hz
 - Rechargeable battery: 21,6 V, 2200 mAh
 - W x H x D approx. 200 x 1050 x 260 mm (with suction tube)



Charging station / wall mount (incl. mounting material)

Powerful
Lithium-ion
battery 21.6 V /
2200 mAh



180° rotatable double joint for optimal mobility



Electrical, rotating turbo floor brush

Art. no. 617 141
EAN 4 004 470 171 419

PU 1

Art. no. 619 497
EAN 4 004 470 194 975 PU 2
Art. no. 619 496
EAN 4 004 470 194 968 PU 2





Incl. brush tool



Incl. crevice tool



Incl. wall mount



Big operating range (6.5 m connection cable)

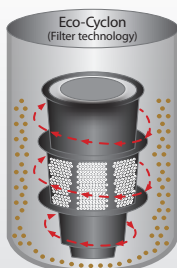

Eco-Cyclon filter technology

2in1

A+



A

Floor vacuum cleaner
BS 1948 N CB

- 2 in 1 – Floor and hand vacuum cleaner
- Eco-Cyclon
- Also suitable as hand vacuum cleaner for vacuuming of: furniture, upholstery, frames, curtains, books, computers, cars and much more
- Multi filter system
- HEPA-Filter
- Two part aluminium tube (40–85 cm)
- Big operating range (6.5 m connection cable)
- Switchable floor brush
- Easy to clean
- Low weight
- Incl. wall mount (space saving)
- Accessories: Two part aluminium tube, wall mount, brush tool, crevice tool, floor brush
- 220–240 V, 50/60 Hz, 600 W
- W x H x D approx. 230 x 1300 x 130 mm (with suction tube)



Incl. floor brush (switchable)

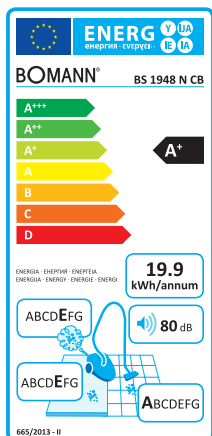

Floor vacuum cleaner
BS 9021 CB

- Floor vacuum cleaner with energy-saving 700 watt
- 4-fold microfilter system
- Metal telescopic tube
- Switchable floor brush
- Dust bag change indicator
- Practical carrying handle
- Automatic cable rewind
- Space-saving parking aid
- Dual accessory: combined brush/crevice nozzle
- 220–240 V, 50/60 Hz, 700 W
- W x H x D approx. 245 x 229 x 316 mm

Spare bags:

SSB 101
Art. no. 282 047
EAN 4 006 160 820 478

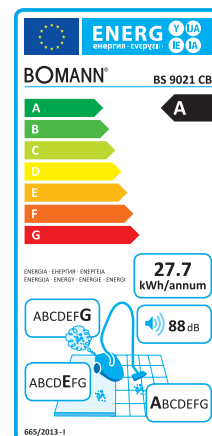

Art. no. 619 489
EAN 4 004 470 194 890 PU 2
Art. no. 619 483
EAN 4 004 470 194 838 PU 2

Art. no. 690 211
EAN 4 004 470 902 112 PU 1





A

Floor vacuum cleaner
BS 9019 N CB

- Floor vacuum cleaner with energy-saving 700 watt
 - 5-layer micro-filter system
 - Stainless steel suction tube
 - Switchable floor brush
 - Dust bag change indicator
 - Practical carrying handle
 - Automatic cable rewind
 - Space-saving parking aid
 - 2-fold accessories: combined brush/crevice nozzle
- 220–240 V, 50/60 Hz, 700 W
■ WxHxD approx. 256 x 205 x 310 mm

Spare bags:

SSB 98
Art. no. 282 193
EAN 4 006 160 821 932

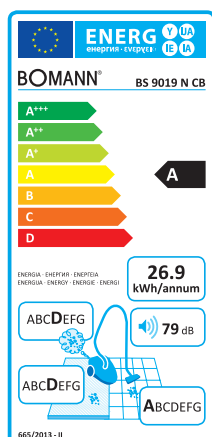

A



ELECTRONIC

Floor vacuum cleaner
BS 9014 CB

- Electronic power adjustment
 - 4-layer micro-filter system
 - Includes HEPA exhaust filter
 - Stainless steel suction tube (approx. 84 cm length)
 - Extra large operation range (approx. 8.30 m)
 - Switchable floor brush
 - Dust bag change indicator
 - Rubberized rollers (ideal for sensitive floors)
 - Practical carrying handle
 - Automatic cable rewind
 - Space-saving parking aid
 - Integrated accessory tray
 - 2-fold accessories: combined brush/crevice nozzle
- 220–240 V, 50/60 Hz, 800 W
■ WxHxD approx. 255 x 205 x 370 mm

Spare bags:

SSB 98
Art. no. 282 193
EAN 4 006 160 821 932

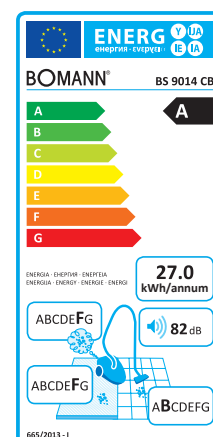



A **ELECTRONIC**



A **ELECTRONIC**

Floor vacuum cleaner
BS 9020 N CB

Floor vacuum cleaner
BS 9015 CB

- Floor vacuum cleaner with energy-saving 700 watt
- Electronic power adjustment
- 5-layer micro-filter system
- Includes HEPA exhaust filter
- Stainless steel suction tube (approx. 84 cm length)
- Extra large operation range (approx. 8.30 m)
- Switchable floor brush
- Incl. parquet brush
- Dust bag change indicator (electronic)
- Rubberised rollers (ideal for sensitive floors)
- Practical carrying handle
- Automatic cable rewind
- Space-saving parking aid
- 3-fold accessories: crevice nozzle, upholstery nozzle, 360° brush attachment

- 220–240 V, 50/60 Hz, 700 W
- WxHxD approx. 291 x 246 x 457 mm

Spare bags:

SSB 101
Art. no. 282 047
EAN 4 006 160 820 478



Incl. parquet brush

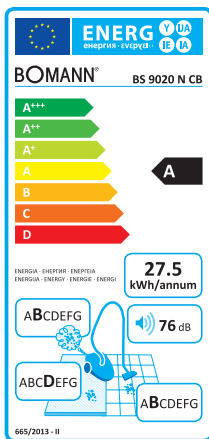

- Floor vacuum cleaner with energy-saving 700 watt
- Electronic power adjustment
- 4-layer micro-filter system
- Includes HEPA exhaust filter
- Stainless steel suction tube (approx. 84 cm length)
- Extra large operation range (approx. 8.30 m)
- Switchable floor brush
- Dust bag change indicator
- Rubberized rollers (ideal for sensitive floors)
- Practical carrying handle
- Automatic cable rewind
- Space-saving parking aid
- 2-fold accessories: combined brush/crevice nozzle

- 220–240 V, 50/60 Hz, 700 W
- WxHxD approx. 295 x 215 x 450 mm

Spare bags:

SSB 101
Art. no. 282 047
EAN 4 006 160 820 478

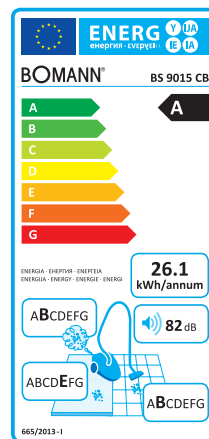

Art. no. 690 206
EAN 4 004 470 902 068 PU 1



Art. no. 690 151
EAN 4 004 470 901 511 PU 1





Floor vacuum cleaner
BS 9022 CB

NEW! **Floor vacuum cleaner**
BS 3000 CB

- Eco-Cyclon floor vacuum cleaner with energy-saving 700 Watt
 - Bagless filter technology
 - 4-fold microfilter system
 - Includes HEPA filter
 - Metal telescopic tube
 - Switchable floor brush
 - Rubberised rollers (ideal for sensitive floors)
 - Practical carrying handle
 - Automatic cable rewind
 - Space-saving parking aid
 - Dual accessory: combined brush/crevice nozzle
- 220–240 V, 50/60 Hz, 700 W
- W x H x D approx. 235 x 290 x 365 mm

- Eco-Cyclon twin spin floor vacuum cleaner with energy-saving 700 Watt
 - Bagless filter technology
 - 4-fold microfilter system
 - HEPA filter (High efficiency particulate air filter)
 - Metal telescopic tube
 - Switchable floor brush
 - Practical carrying handle
 - Automatic cable rewind
 - Space-saving parking aid
 - Dual accessory: combined brush/crevice nozzle
- 220–240 V, 50/60 Hz, 700 W
- W x H x D approx. 340 x 250 x 270 mm

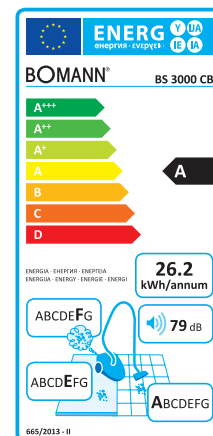
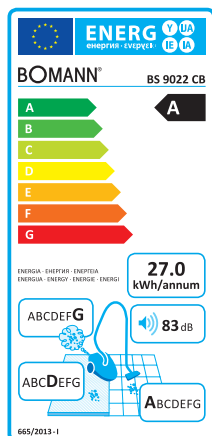

- Art. no. 690 223
EAN 4 004 470 902 235 PU 1
- Art. no. 690 227
EAN 4 004 470 902 273 PU 1
- Art. no. 690 226
EAN 4 004 470 902 266 PU 1

- Art. no. 630 001
EAN 4 004 470 638 097 PU 1
- Art. no. 630 003
EAN 4 004 470 638 219 PU 1
- Art. no. 630 002
EAN 4 004 470 638 202 PU 1





Turbo brush for easy removal for example of animal hair and fluff – ideal for pet owners



Turbo brush for easy removal for example of animal hair and fluff – ideal for pet owners



NEW! Floor vacuum cleaner
BS 9022 P CB

NEW! Floor vacuum cleaner
BS 3000 P CB

- Eco-Cyclon floor vacuum cleaner with energy-saving 700 Watt
- Incl. turbo brush for easy removal for example of animal hair and fluff – ideal for pet owners
- Bagless filter technology
- 4-fold microfilter system
- HEPA filter (High efficiency particulate air filter)
- Metal telescopic tube
- Switchable floor brush
- Rubberised rollers (ideal for sensitive floors)
- Practical carrying handle
- Automatic cable rewind
- Space-saving parking aid
- 3-fold accessories: turbo brush, combined brush/crevice nozzle

- Eco-Cyclon twin spin floor vacuum cleaner with energy-saving 700 Watt
- Incl. turbo brush for easy removal for example of animal hair and fluff – ideal for pet owners
- Bagless filter technology
- 4-fold microfilter system
- HEPA filter (High efficiency particulate air filter)
- Metal telescopic tube
- Switchable floor brush
- Practical carrying handle
- Automatic cable rewind
- Space-saving parking aid
- 3-fold accessories: turbo brush, combined brush/crevice nozzle

- 220–240 V, 50/60 Hz, 700 W
- W x H x D approx. 235 x 290 x 365 mm

- 220–240 V, 50/60 Hz, 700 W
- W x H x D approx. 340 x 250 x 270 mm

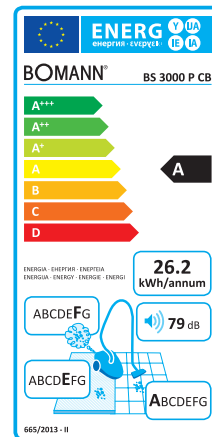
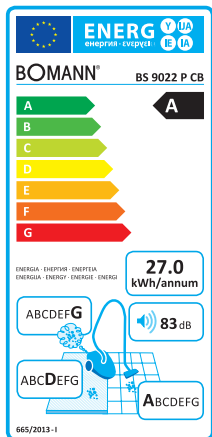

Art. no. 690 229
EAN 4 004 470 902 297 PU 1

Art. no. 630 004
EAN 4 004 470 300 048 PU 1





A



ELECTRONIC

Floor vacuum cleaner
BS 9027 N CB

73

- Eco-Cyclon twin spin floor vacuum cleaner with energy-saving 700 Watt
 - Bagless Cyclon Twin Spin technique allows continual high suction power
 - Electronic power adjustment
 - 4-fold filter system
 - Stainless steel telescopic tube (approx. 92 cm length)
 - Extra-large operation range (approx. 8.30 m)
 - Switchable floor brush
 - Incl. parquet brush
 - Rubberised rollers (ideal for sensitive floors)
 - Practical carrying handle
 - Automatic cable rewind
 - Space-saving parking aid
 - Dual accessory: combined brush/crevice nozzle
- 220-240 V, 50/60 Hz, 700 W
 - WxHxD approx. 250 x 330 x 380 mm



Incl. parquet brush

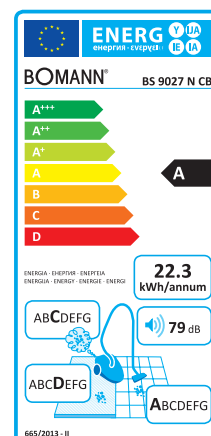

- Art. no. 690 276
EAN 4 004 470 902 761 PU 1
- Art. no. 690 277
EAN 4 004 470 902 778 PU 1
- Art. no. 690 279
EAN 4 004 470 902 792 PU 1





Floor vacuum cleaner
BS 9018 N CB

- Floor vacuum cleaner with energy-saving 700 Watt
- Electronic power adjustment
- Includes 2 HEPA filter
- Height-adjustable telescopic tube
- Switchable floor brush
- Bagless filtertechnology (no need to purchase dust bags)
- Easy-to-empty, transparent dust-collecting container replaces conventional dust bag
- Tank volume: 1.25 l
- Motor protection filter (washable)
- Rubberised rollers (ideal for parquet floors)
- Automatic cable rewind
- Space-saving parking aid
- 3-fold accessories: combined brush/crevice nozzle, upholstery nozzle
- 220–240 V, 50/60 Hz, 700 W
- W x H x D approx.
365 x 265 x 285 mm

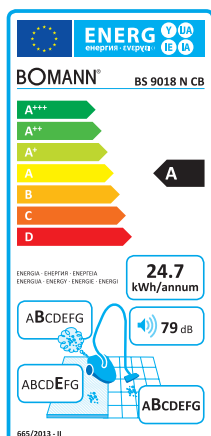

Wet and dry vacuum cleaner
BS 9000 CB

- Stainless steel housing
- Large and comfortable wet and dry vacuum cleaner with powerful 1400 watt max.
- Tank capacity: approx. 20 litres
- Multi filter system
- Incl. blower function, e.g. for easy removal of leaves
- Draws coarse dirt as effectively as liquids
- Optimal stability through 4 rollers
- Deflection rollers (360°) allow smooth and flexible working
- 2-part robust suction tube
- Overflow protection by float valve
- Practical holder on the vacuum cleaner for quick access and tidied accessory
- 5 m cable allows large operation range
- Accessories: brush/crevice nozzle, wet/dry brush, washable permanent filter
- 220–240 V, 50/60 Hz, 1200–1400 W
- W x H x D approx. 405 x 530 x 405 mm



Also ideal for the use on laminate, carpets etc.

Accessories: brush nozzle and crevice nozzle

Art. no. 609 187
EAN 4 004 470 901 870 PU 1



Art. no. 690 000
EAN 4 004 470 900 002 PU 1



4in1

Dry vacuum cleaning
Wet vacuum cleaning
Shampoo function
Blower function

Stainless steel tube



Upholstery nozzle

Shampoo nozzle

Wet/dry brush

Crevice nozzle

NEW! Shampoo vacuum cleaner BSS 6000 CB

75

- Comfortable shampoo vacuum cleaner with powerful 1200 watts
 - Cleans away larger dirt just as effectively as fluids
 - Comes with separate removable tank for cleaning agent (4 litres)
 - Spray extraction for even & large-scale spreading of the cleaning agent
 - Perfect stability thanks to four pulleys
 - 4 pulleys (360°) allow for easy and flexible cleaning
 - 2-piece stainless steel cleaner pipe
 - Big, sturdy carrying handle
 - Dual filter system
 - Practical bracket holder for ready-to-hand and organized accessories
 - Comes with drain appliance to discharge absorbed fluids
 - Blower function, e.g. to remove leaves easily
 - For easy and thorough cleaning of fabrics, areas, and hard floors (e.g. stone, tiles, linoleum)
 - For deep-cleaning of upholstery and rugs
 - Accessories: Crevice nozzle, parquet brush, big suction brush, e.g. to clean carpet floors, tiles; small suction brush, e.g. to clean upholstery
 - Tank volume (wet cleaning operation) 20 litres
 - Cleaning container volume: 4 litres
- 220–240 V, 50/60 Hz, 1200 W
 - W x H x D approx. 370 x 500 x 430 mm



Large tank volume
(approx. 20 litres)



Shampoo tank
(approx. 4 litres)



Shampoo cleaner



Wet/dry vacuum cleaner



Upholstery cleaner



Accessories-holder



Art. no. 660 001
EAN 4 004 470 600 018

PU 1





Electronic bathroom scale PW 1417 CB

- Electronic glass bathroom scale with easy-to-read LCD display
- Weighing units in kg, lb, st (convertible)
- Measurement range of 2.5–150 kg (subdivided into 100 g steps)
- Low-maintenance standing surface
- Non-slip feet ensuring secure base
- Automatic switch-off (prolongs battery life)
- Battery operation: 1x CR 2032 (battery not included)
- W x H x D approx. 330 x 25 x 300 mm

Electronic bathroom scale PW 1418 CB

- Electronic glass bathroom scale with easy-to-read LCD display
- Weighing units in kg, lb, st (convertible)
- Measurement range of 2.5–150 kg (subdivided into 100 g steps)
- Low-maintenance standing surface
- Non-slip feet ensuring secure base
- Automatic switch-off (prolongs battery life)
- Battery operation: 1x CR 2032 (battery not included)
- W x H x D approx. 320 x 25 x 320 mm

Foot massager FM 8000 CB

- Intense whirlpool effect
- Massage burls for stimulating the foot reflex zones
- Additional massage roller, detachable, for selective foot reflex zone massage
- Heated footrest
- 4-level switches:
 - 0 = off
 - 1 = massage,
 - 2 = warm/whirl
 - 3 = warm/whirl/massage
- Can be used with and without water
- Splash guard, detachable
- Water level mark
- Spout
- Large rubber feet for slip-proof stand
- 230 V, 50 Hz, 90 W
- W x H x D approx. 300 x 120 x 380 mm



● Art. no. 614 171
EAN 4 004 470 141 719 PU 6



● Art. no. 614 181
EAN 4 004 470 141 818 PU 6



● Art. no. 680 000
EAN 4 004 470 800 005 PU 3





2in1

Nose and ear hair remover NE 8008 CB

- Conveniently and simply removes troublesome hairs in the nose and ears
- Includes light for improved personal grooming
- Removable fine-steel shearing head for cleaning
- On/off switch
- Incl. covering cap for the shearing head
- Battery operation: 1x 1.5 V (AA) (batteries not included)
- WxHxD approx. 30 x 130 x 35 mm

Hair and beard trimmer HSM 8006 CB

- Stainless steel precision shaving head for uniform haircut
- Stainless steel blade
- Stepless cutting length adjustment for efficient use of the comb attachments
- 4 comb attachments: 3, 6, 9, 12 mm
- Rubberized inlay for non-slip handling
- Accessories:
 - 4 comb attachments
 - Cleaning brush
 - Shearing head protection
 - Hanging loop
- 230–240 V, 50 Hz, 9 W
- WxHxD approx. 65 x 200 x 55 mm

Hair trimmer set HSM 8007 NE CB

- **Hair and beard trimmer:**
 - Stainless steel precision shaving head for uniform haircut
 - Stainless steel blade
 - Stepless cutting length adjustment for efficient use of the comb attachments
 - 4 comb attachments: 3, 6, 9, 12 mm
 - Soft touch inlay for non-slip handling
 - Accessories: 4 comb attachments, cleaning brush, shearing head protection, comb, hanging loop
 - 230–240 V, 50 Hz, 9 W
 - WxHxD approx. 65 x 200 x 55 mm
- **Nose and ear hair remover:**
 - Gently and comfortably removes unsightly nose and ear hair
 - Stainless steel shaving head, can be detached for cleaning
 - Incl. cap for shaving head
 - Battery operation: 1x 1.5 V (AA) (batteries not included)
 - WxHxD approx. 30 x 130 x 30 mm



Includes light for improved personal grooming

Promotional Packaging



Art. no. 680 080
EAN 4 004 470 800 807 PU 12



Art. no. 680 061
EAN 4 004 470 800 616 PU 12



Art. no. 680 071
EAN 4 004 470 800 715 PU 10





78

Hot air styler CB 856

- 2 power level
- Roll key for accessories
- Ergonomically formed
- Cable with swivel cord 360°
- Safety cut-out
- 220–240 V, 50 Hz, 300 W
- W x H x D approx. 320 x 50 x 50 mm

Hot air curling brush HAS 8101 CB

- Hot air styler for even and gentle heat distribution
- 3 exchangeable brush attachments with smooth bristles for hair gentle styling:
 - 1 volume styler
 - 2 round brushes individual for all hair length and requirements (15 mm Ø and 25 mm Ø)
- 2 temperature-/power settings
- Cold setting for style fix and hairstyle finish
- Ergonomic design handle
- Cable attached via 360° turnable joint
- Overheating protection
- Hanging loop
- 230 V, 50/60 Hz, 600 W
- W x H x D approx. 365 x 50 x 50 mm

Hair dryer HT 8002 CB

- Compact travelling hair dryer
- 2 temperature/power settings
- Removable shaped nozzle, rotatable through 360°
- Rubber profile on the casing avoid slipping
- Overheating protection
- Hanging loop
- 230 V, 50 Hz, 1200 W
- W x H x D approx. 111 x 210 x 75 mm



Volume styler

1 round brush
(15 mm Ø)1 round brush
(25 mm Ø)

Art. no. 608 560
EAN 4 004 470 085 600

PU 12



Art. no. 681 011
EAN 4 004 470 810 110

PU 6



Art. no. 680 029
EAN 4 004 470 800 296

PU 12





Ion technology function

Hair dryer HTD 8005 CB

- Compact travelling hair dryer
- Folding handle
- 2 temperature/power settings
- Removable shaped nozzle, rotatable through 360°
- Soft touch housing – rubberised surface to prevent slipping when putting down
- Includes volume diffuser and see-through bag for practical storage and when travelling
- Switchable voltage: 110/230 V
- Hanging loop
- 110/230 V, 50/60 Hz, 1100–1200 W
- WxHxD approx. 170 x 235 x 75 mm

Professional hairstyler HTD 889 CB

- Professional hairstyler with 2000 watt max.
- 3 temperature/power settings
- 2 speed settings
- Cool Shot
- Professional volume diffuser and shaping nozzle
- Air intake filter, removable
- Rubberised housing
- Avoid slipping
- Soft-touch grip
- Overheating protection
- Hanging loop
- 220–240 V, 50/60 Hz, 1800–2000 W
- WxHxD approx. 270 x 270 x 90 mm

Hair dryer HT 1844 CB

- Professional hair dryer with powerful 2100 watt
- Ion technology function – improved possibilities of hairstyling thanks to antistatic effect, the hair is not dried out and becomes smooth and shiny
- 3 temperature/power settings
- 2 speed settings
- Cool Shot
- Shaped nozzle, 360° swiveling (removable)
- LED pilot lamp
- Overheating protection
- Hanging loop
- 230 V, 50 Hz, 2100 W
- WxHxD approx. 220 x 255 x 90 mm



Ø 23 cm



Ø 30 cm



Ø 40 cm

Table fan
VL 1137 CB

- Oscillating (can be switched off)
- Adjustable angle of inclination
- Metal protection grid
- Safe base
- Ø approx. 23 cm
- 2 speed level
- 3-level switches (0-1-2)
- Practical carrying handle
- 220–240 V, 50/60 Hz, 30 W
- WxHxD approx. 275 x 375 x 220 mm

Table fan
VL 1138 CB

- Oscillating (can be switched off)
- Adjustable angle of inclination
- Metal protection grid
- Safe base
- Ø approx. 30 cm
- 3 speed level
- 4-level switches (0-1-2-3)
- Practical carrying handle
- 220–240 V, 50/60 Hz, 40 W
- WxHxD approx. 340 x 480 x 245 mm

Standing fan
VL 1139 S CB

- Oscillating (can be switched off)
- Height-adjustable
- Adjustable angle of inclination
- Metal protection grid
- Safe base
- Ø approx. 40 cm
- 3 speed level
- 4-level switches (0-1-2-3)
- Practical carrying handle
- 220–240 V, 50/60 Hz, 45 W
- WxHxD approx. 430 x 1250 x 640 mm

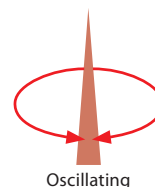
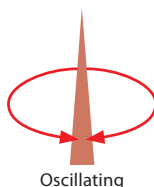
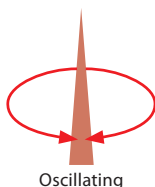

Art. no. 611 370
EAN 4 004 470 611 373 PU 4



Art. no. 611 380
EAN 4 004 470 611 380 PU 4



Art. no. 611 390
EAN 4 004 470 611 397 PU 3





Air dehumidifier
LE 1150 CB

- Dehumidification power: 12 L/24 h
 - Air circulation in m³:
Level 1: approx. 100 m³/h
Level 2: approx. 140 m³/h
 - LED display (blue illuminated)
 - Humidity indicator
 - Electronic humidity control
 - The desired humidity can be set from 40 to 80 %
 - 24 hour timer
 - 1 L water tank (detachable)
 - Fold-out carrying handle
 - Convenient rollers
 - Automatic stop + warning signal with full tank
 - Low noise
 - Removable air filter (easy to clean)
 - Hose connector for permanent water drain
 - Incl. water hose (1 m)
 - On/off switch
 - Coolant: R134A
 - Ideal for rooms up to 15 m²
- 220–240 V, 50 Hz, 220 W
 - W x H x D approx. 280 x 520 x 185 mm



LED display



Hose connector for permanent water drain



Fan heater
HL 1095 CB

- 2 heat settings (1000/2000 watt max.)
 - Cold (ventilator)
 - Infinitely adjustable thermostat
 - Indicator light
 - 2 different ways of setting up
 - Safe base
 - Sturdy carrying handle
 - Overheating protection
- 220–240 V, 50 Hz, 1800–2000 W
 - W x H x D approx. 248 x 120 x 250 mm



2 different ways of setting up



Fan heater
HL 1096 CB

- 2 heat settings (1000/2000 watt)
 - Cold (ventilator)
 - Infinitely adjustable thermostat
 - Indicator light
 - Safe base
 - Sturdy carrying handle
 - Overheating protection
- 220–240 V, 50 Hz, 1800–2000 W
 - W x H x D approx. 230 x 138 x 262 mm





Ceramic fan heater HL 1097 CB

- PTC ceramic heater element for healthy, safe, quiet and efficient heating
 - Low dust accumulation
 - Quick and effective heating
 - Long service life
 - Robust and durable
 - 7 level switches
 - 2 heat settings (750/1500 W)
 - Oscillating (can be deactivated)
 - Cold setting (fan blower)
 - Steplessly adjustable thermostat
 - Safety switch for fire protection
 - Stable stand
 - Robust carry handle (foldable)
 - Overheat protection
- 220–240 V, 50 Hz, 1500 W
 - WxHxD approx. 191 x 267 x 141 mm



Oscillating

Ceramic fan heater HL 1120 CB

- PTC ceramic heater element for healthy, safe, quiet and efficient heating
 - Low dust accumulation
 - Quick and effective heating
 - Robust and insensitive by durable ceramic heater
 - 4 level switches
 - 2 heat settings (1000/2000 W)
 - Adjustable angle of inclination (90°)
 - Cold setting (fan blower)
 - Steplessly adjustable thermostat
 - High stability due to sturdy metal frame
 - Robust carry handle
 - Overheating protection
- 220–240 V, 50 Hz, 2000 W
 - WxHxD approx. 210 x 217 x 160 mm

● Art. no. 610 971
EAN 4 004 470 109 719 PU 4



● Art. no. 611 209
EAN 4 004 470 112 092 PU 4





A+

A++

Cool box
KB 9486 CB

Cool box
KB 9487 CB

- Suitable for cooling and warming
- Perfect for camping, travel and shopping
- Capacity (gross capacity): ca. 25 litre max.
- Even cooling by integrated fan
- Powerful, maintenance-free Peltier cooling/heating system
- Energy saving function
- Double walled plastic casing with high quality isolation
- Special sealing rubber in the lid reduces condensation
- Control lights for cooling and warming function
- Foldable handle
- Removable lid
- Accessory: 12 V connecting cable (detachable), 230 V connecting cable (detachable)

- Power supply:
 - Mains adapter connection: DC 12 V, 40/48 W
 - Mains adapter connection: AC 220–240 V, ~ 50/60 Hz, 52/58 W, 11 W (ECO mode)

- W x H x D approx. 405 x 435 x 300 mm
- Energy class: A+

- Suitable for cooling and warming
- Perfect for camping, travel and shopping
- Capacity (gross capacity): ca. 30 litre max.
- Even cooling by integrated fan
- Powerful, maintenance-free Peltier cooling/heating system
- Energie saving function
- Double walled plastic casing with high quality isolation
- Special sealing rubber in the lid reduces condensation
- Control lights for cooling and warming function
- Foldable handle
- Removable lid
- Cable storage compartment
- Accessory: 12 V connecting cable, 230 V connecting cable

- Power supply:
 - Mains adapter connection: DC 12 V, 40/48 W
 - Mains adapter connection: AC 220–240 V, ~ 50/60 Hz, 52/58 W, 8 W (ECO mode)

- W x H x D approx. 405 x 435 x 300 mm
- Energy class: A++



For all standard 0.75 / 1.0 / 1.5-litre bottles

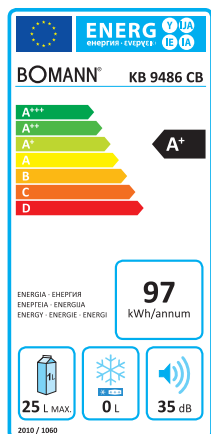

For all standard 0.75 / 1.0 / 1.5-litre bottles

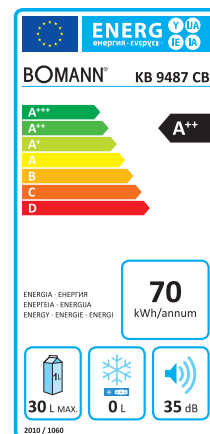

Art. no. 694 861
EAN 4 004 470 948 615

PU 1



Art. no. 694 871
EAN 4 004 470 948 714

PU 1





A

Wine cooler KSW 344

- Bottle capacity: 16 at 0.75 litres
- Net capacity: 48 litres
- Control panel with LED-display (blue illuminated)
- Electronical temperature setting and -control
- Eco-friendly, without coolant

General

- Wine storage cabinet
- Thermoelectric cooling
- Climate class N (+16 °C to +32 °C)
- Low-noise 43 dBA, without vibration
- Without compressor

Features

- Digital temperature settings and display (blue illuminated)
 - Temperature settings from +11 °C to +18 °C, max. 14 °C below ambient temperature
 - LED interior light (separate switchable)
 - 3 removable shelves made of chrome (W 35.0 x D 26.5 cm)
 - Double pane door with recessed handle
 - Housing black color, door frame in silver color
 - Adjustable feet
- 230 V~, 70 W
■ W x H x D approx. 420 x 520 x 480 mm

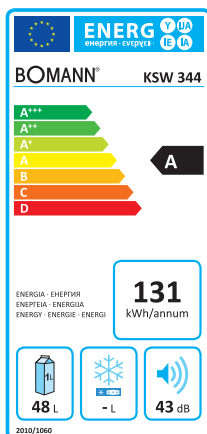

B

Wine cooler KSW 345

- Bottle capacity: 18 at 0.75 litres
- Net capacity: 54 litres
- Control panel with LED-display (blue illuminated)
- Electronical temperature setting and -control
- Eco-friendly, without coolant

General

- Wine storage cabinet
- Thermoelectric cooling
- Climate class N (+16 °C to +32 °C)
- Low-noise 42 dBA, without vibration
- Without compressor

Features

- Digital temperature settings and display (blue illuminated)
 - Temperature settings from +11 °C to +18 °C, max. 14 °C below ambient temperature
 - LED interior light (separate switchable)
 - 5 removable shelves made of chrome (W 27.5 x D 26.5 cm)
 - Double pane door with recessed handle
 - Housing black color, door frame in silver color
 - Adjustable feet
- 230 V~, Connection power: 70 W
■ W x H x D approx. 345 x 636 x 515 mm

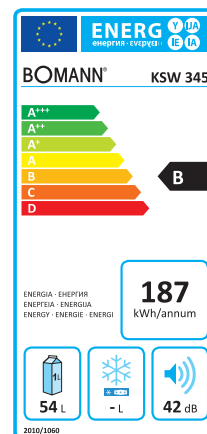

● Art. no. 734 400
EAN 4 004 470 734 409 PU 1



● Art. no. 734 500
EAN 4 004 470 734 508 PU 1





Replacement bottle/ Replacement jars

Replacement bottle for Smoothie maker SM 386 CB

Art. no. 264 559
EAN 4006 160 645 590 PU 6

Replacement jars for Yoghurt-Maker JM 1025 CB

Art. no. 251 125
EAN 4006 160 511 253 PU 4



Replacement cartridges

Replacement cartridges for DBS 778 CB, DBS 783 CB

Art. no. 8 934 610
EAN 4006 160 632 583 PU 3

Replacement cartridges for DBS 792 CB, DBS 1793

Art. no. 8 936 110
EAN 4006 160 632 606 PU 3



Spare rolls for bag sealer

Spare rolls for FS3261

Art. no.: 8 900 216
EAN 4 006 160 900 217 PU 10



Dust bags

You will find other accessory articles under www.bomann.de

Vacuum cleaners	Article no.	EAN no.	Bomann type	Swirl type
BS 902 CB	282 193	4 004 470 821 932	SSB 98	Y 98
BS 911 CB	282 047	4 006 160 820 478	SSB 101	Y 05
CB 925	309 250	4 004 470 309 256	B 45	Y 101
CB 917 / CB 918 / CB 929	282 049	4 006 160 820 492	SSB 104	Y 104
CB 940	282 047	4 006 160 820 478	SSB 101	Y 93
CB 941	309 410	4 004 470 309 416	B 49	Y 101
CB 942	282 047	4 006 160 820 478	SSB 101	Y 101
CB 946	282 193	4 006 160 821 932	B 52/SSB 98	Y 98
CB 948	282 047	4 006 160 820 478	SSB 101	Y 101
CB 949	282 047	4 006 160 820 478	SSB 101	Y 05
CB 950	282 207	4 006 160 822 076	SSB 30	Y 30
CB 952 / CB 953	282 049	4 006 160 820 492	SSB 104	Y 104
CB 957	282 047	4 006 160 820 478	SSB 101	Y 101
BS 961 CB	282 047	4 006 160 820 478	SSB 101	Y 101
CB 962	282 049	4 006 160 820 492	SSB 104	Y 104
CB 965	282 047	4 006 160 820 478	SSB 101	Y 93
CB 966	282 047	4 006 160 820 478	SSB 101	Y 05
BS 968 CB	282 193	4 006 160 821 932	SSB 98	Y 298
BS 973 CB / BS 986 CB	282 193	4 006 160 821 932	SSB 98	Y 298
BS 974 CB	282 193	4 006 160 821 932	SSB 98	Y 298
BS 976 CB	-	-	-	Y 293
BS 980 CB	282 047	4 006 160 820 478	SSB 101	Y 50
BS 981 CB	-	-	-	R 23
BSS 982 CB	8126102	-	BSS 1261	R 23
BS 985 CB / BS 988 CB	282 047	4 006 160 820 478	SSB 101	Y 93
BS 987 CB	282 047	4 006 160 820 478	SSB 101	Y 101
BS 989 CB / BS 9014 CB / BS 9019 CB	282 193	4 006 160 821 932	SSB 98	Y 98
CB 991	282 047	4 006 160 820 478	SSB 101	Y 05
CB 992	282 193	4 006 160 821 932	SSB 98	Y 98
CB 993	282 207	4 006 160 822 076	SSB 30	Y 230
BS 9010 CB / BS 9011 CB / BS 9015 CB / BS 9020 CB	282 047	4 006 160 820 478	SSB 101	-



Filter-sets

Vacuum cleaners	Article no.	EAN no.	Bomann type
BS 912 CB	8912800	-	Filterset BS 1280
CB 954	282 840	4 006 160 828 405	Filterset BS 1228
CB 955	612 290	4 006 160 122 909	Filterset BS 1229
CB 956	282 862	4 006 160 828 627	Filterset BS 1236
BS 958 CB	282 918	4 006 160 829 181	Filterset BS 1273
CB 964	282 886	4 006 160 828 863	Filterset BS 1240
BS 970 CB	271 576	4 006 160 715 767	Filterset BS 1247
BS 971 CB	282 906	4 006 160 829 068	Filterset BS 1248
BS 972 CB	282 907	4 006 160 829 075	Filterset BS 1249
BS 975 CB	282 914	4 006 160 829 143	Filterset BS 1253
BS 979 CB	271 596	4 006 160 715 965	Filterset BS 1256
BS 983 CB	282 907	4 006 160 829 075	Filterset BS 1249
BS 984 CB	271 575	4 006 160 715 750	Filterset BS 1255
CB 997	282 850	4 006 160 828 504	Filterset BS 1234



HEPA-filter

Vacuum cleaners	Article no.	EAN no.	Bomann type
CB 939	209 390	4 004 170 093 905	-
CB 950	282 203	4 006 160 822 038	Filter BS 1224

TECHNICAL DATA FOR VACUUM CLEANERS Commission Delegated Regulation (EU) No. 665/2013

Bomann							
Model		BS 1948 N CB	BS 3000 CB	BS 3000 P CB	BS 9014 CB	BS 9015 CB	BS 9018 N CB
Energy efficiency class ¹⁾		A+	A	A	A	A	A
Energy consumption							
Annual energy consumption ²⁾	kWh/year	19.9	26.2	26.2	27.0	26.1	24.7
Cleaning performance class							
Carpet cleaning performance class		E	E	E	F	E	E
Hard floor cleaning performance class		A	A	A	B	B	B
Dust re-emission class		E	F	F	F	B	B
Sound power level	dB(A) re 1pW	80	79	79	82	82	79
Rated input power	W	600	700	700	800	700	700

Bomann							
Model		BS 9019 N CB	BS 9020 N CB	BS 9021 CB	BS 9022 CB	BS 9022 P CB	BS 9027 N CB
Energy efficiency class ¹⁾		A	A	A	A	A	A
Energy consumption							
Annual energy consumption ²⁾	kWh/year	26.9	27.5	27.7	27.0	27.0	22.3
Cleaning performance class							
Carpet cleaning performance class		D	D	E	D	D	D
Hard floor cleaning performance class		A	B	A	A	A	A
Dust re-emission class		D	B	G	G	G	C
Sound power level	dB(A) re 1pW	79	76	88	83	83	79
Rated input power	W	700	700	700	700	700	700

¹⁾ A (highest efficiency) to G (lowest efficiency).

²⁾ Indicative annual energy consumption (kWh per year), based on 50 cleaning tasks.
Actual annual energy consumption will depend on how the appliance is used.

The device meets the European standards and directives in the current version at delivery:

- Low Voltage Directive (LVD) 2006/95/EC
- Electromagnetic Compatibility (EMC) Legislation Directive 2004/108/EC
- Ecodesign requirements for vacuum cleaners COMMISSION REGULATION (EU) No 666/2013

TECHNICAL DATA FOR HOUSEHOLD REFRIGERATORS Commission Delegated Regulation (EU) No. 1060/2010

Bomann					
Model	KB 9486 CB	KB 9487 CB	KSW 344	KSW 345	
Category ¹⁾	10	10	2	2	
Energy efficiency class ²⁾ A+++ (highest efficiency) to G (lowest efficiency)	A+	A++	A	B	
Consumption data					
Annual energy consumption ³⁾	kWh	97	70	131	187
Net capacity cooling total	l	25	30	48	54
Net capacity freezing	l	-	-	-	-
Star rating ⁴⁾		-	-	-	-
Frost-free		-	-	-	-
Temperature rise time	h	-	-	-	-
Freezing capacity	kg/ 24 h	-	-	-	-
Climate class ⁵⁾		SN/N	SN/N	N	N
Noise level	dB(A) re 1pW	35	35	43	42
Design		mobile	mobile	-	-

¹⁾ Category: 1 = Refrigerator with one or more fresh-food storage compartments, 2 = Refrigerator-cellar, Cellar and Wine storage appliances, 3 = Refrigerator-chiller and Refrigerator with a 0-star compartment, 4 = Refrigerator with a one-star compartment, 5 = Refrigerator with a two-star compartment, 6 = Refrigerator with a three-star compartment, 7 = Refrigerator-freezer, 8 = Upright freezer, 9 = Chest freezer, 10 = Multi-use and other refrigerating appliances.

²⁾ A+++ (highest efficiency) to G (lowest efficiency).

³⁾ Annual energy consumption „XYZ“ kWh per year based on standard test results for 24 h. Actual energy consumption will depend on how the appliance is used and where is located.

⁴⁾ * = compartment: a frozen-food storage compartment in which the temperature is not warmer than -6°C.

*** = compartment: a frozen-food storage compartment in which the temperature is not warmer than -18°C.

(*)*** = food freezer compartment in which the temperature is not warmer than -18°C and a minimum freezing capacity in 24 h.

⁵⁾ Climate class SN: ambient temperature of +10°C up to +32°C. Climate class N: ambient temperature of +16°C up to +32°C. Climate class ST: ambient temperature of +16°C up to +38°C. Climate class T: ambient temperature of +16°C up to +43°C.







Headquarter



Logistic Center (approx. 60.000 m²)



Showroom



Quality assurance

BOMANN®

C. Bomann GmbH
Heinrich-Horten-Straße 17
47906 Kempen
Germany

Telephone: +49 2152 8998-0
Telefax: +49 2152 8998-911

mail@bomann.de
www.bomann-germany.de